

Panasonic®

Model No.

TH-42PF30ER

TH-50PF30ER

Operating Instructions High Definition Plasma Display



HDMI

English

Please read these instructions before operating your set and retain them for future reference.



TQB0E2161U

Dear Panasonic Customer

Welcome to the Panasonic family of customers. We hope that you will have many years of enjoyment from your new Plasma Display.

To obtain maximum benefit from your set, please read these Instructions before making any adjustments, and retain them for future reference.

Retain your purchase receipt also, and note down the model number and serial number of your set in the space provided on the rear cover of these instructions.

Visit our Panasonic Web Site <http://panasonic.net>

Table of Contents

| | | | |
|--|-----------|--|-----------|
| Important Safety Notice | 3 | Reduces screen image retention | 38 |
| Safety Precautions | 4 | Extended life settings | 38 |
| 3D Safety Precautions | 7 | Reduces power consumption | 41 |
| Accessories | 9 | Customizing the Input labels | 42 |
| Accessories Supply | 9 | Selecting the On-Screen Menu Language | 43 |
| Remote Control Batteries | 9 | Display orientation | 43 |
| Connections | 10 | Setup for MULTI DISPLAY | 44 |
| Speaker connection..... | 10 | How to Setup MULTI DISPLAY | 44 |
| AC cord connection and fixing, cable fixing..... | 10 | ID Remote Control Function | 45 |
| Video equipment connection | 11 | Set up for Portrait | 46 |
| VIDEO and COMPONENT / RGB IN connection ... | 11 | How to setup Portrait..... | 46 |
| HDMI connection | 12 | Setup for Input Signals | 48 |
| DVI-D IN connection..... | 12 | Component / RGB-in select..... | 48 |
| PC Input Terminals connection..... | 13 | YUV / RGB-in select..... | 48 |
| SERIAL Terminals connection | 14 | Signal menu | 49 |
| Power On / Off | 15 | Network Setup | 52 |
| Selecting the input signal | 17 | Options Adjustments | 53 |
| Basic Controls | 18 | 3D Safety Precautions (To hide 3D Safety | |
| ASPECT Controls | 20 | Precautions) | 56 |
| Digital Zoom | 21 | Weekly Command Timer | 56 |
| Viewing 3D images | 22 | Audio input select | 58 |
| To view the 3D images | 22 | Touch Panel settings (Settings when using | |
| Troubleshooting for 3D Eyewear | 23 | Touch Panel) | 59 |
| Table of images that can be seen for each 3D | | Using Network Function | 60 |
| Picture Format and the source image format..... | 23 | Example of Network Connection | 60 |
| On-Screen Menu Displays | 24 | Command Control | 60 |
| Adjusting Pos./Size | 25 | PLink™ Protocol..... | 61 |
| Picture Adjustments | 28 | Using Web Browser Control | 62 |
| Advanced settings | 29 | Before Using Web Browser Control..... | 62 |
| Picture Profiles | 30 | Access from Web Browser | 62 |
| Saving profiles | 31 | Display Control (BASIC CONTROL/OPTION | |
| Loading profiles | 32 | CONTROL Screen) | 63 |
| Editing profiles..... | 32 | NETWORK SETTING (Network Setup Screen) | 64 |
| Sound Adjustment | 33 | Password Setting (Password Setup Screen) | 64 |
| SDI Sound Output | 33 | Troubleshooting | 65 |
| PRESENT TIME Setup / Set up TIMER | 34 | List of Aspect Modes | 66 |
| PRESENT TIME Setup..... | 34 | Applicable Input Signals | 67 |
| Set up TIMER..... | 34 | Shipping condition | 68 |
| 3D Settings | 35 | Command list of Weekly Command Timer | 69 |
| Screensaver (For preventing image retention) | 36 | Specifications | 70 |
| Setup of Screensaver Time | 37 | | |

Important Safety Notice

WARNING

- 1) To prevent damage which may result in fire or shock hazard, do not expose this appliance to dripping or splashing.
Do not place containers with water (flower vase, cups, cosmetics, etc.) above the set. (including on shelves above, etc.)
No naked flame sources, such as lighted candles, should be placed on / above the set.
- 2) To prevent electric shock, do not remove cover. No user serviceable parts inside. Refer servicing to qualified service personnel.
- 3) Do not remove the earthing pin on the power plug. This apparatus is equipped with a three pin earthing-type power plug. This plug will only fit an earthing-type power outlet. This is a safety feature. If you are unable to insert the plug into the outlet, contact an electrician.
Do not defeat the purpose of the earthing plug.
- 4) To prevent electric shock, ensure the earthing pin on the AC cord power plug is securely connected.

CAUTION

This appliance is intended for use in environments which are relatively free of electromagnetic fields. Using this appliance near sources of strong electromagnetic fields or where electrical noise may overlap with the input signals could cause the picture and sound to wobble or cause interference such as noise to appear. To avoid the possibility of harm to this appliance, keep it away from sources of strong electromagnetic fields.

IMPORTANT: THE MOULDED PLUG

FOR YOUR SAFETY, PLEASE READ THE FOLLOWING TEXT CAREFULLY.

This display is supplied with a moulded three pin mains plug for your safety and convenience. A 10 amp fuse is fitted in this plug. Shall the fuse need to be replaced, please ensure that the replacement fuse has a rating of 10 amps and that it is approved by ASTA or BSI to BS1362.

Check for the ASTA mark  or the BSI mark  on the body of the fuse.

If the plug contains a removable fuse cover, you must ensure that it is refitted when the fuse is replaced. If you lose the fuse cover the plug must not be used until a replacement cover is obtained. A replacement fuse cover can be purchased from your local Panasonic dealer.

Do not cut off the mains plug.

Do not use any other type of mains lead except the one supplied with this display.

The supplied mains lead and moulded plug are designed to be used with this display to avoid interference and for your safety.

If the socket outlet in your home is not suitable, get it changed by a qualified electrician.

If the plug or mains lead becomes damaged, purchase a replacement from an authorized dealer.

WARNING : — THIS DISPLAY MUST BE EARTHED.

How to replace the fuse. Open the fuse compartment with a screwdriver and replace the fuse.

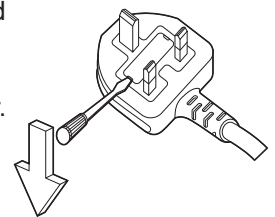

Trademark Credits

- VGA is a trademark of International Business Machines Corporation.
- Macintosh is a registered trademark of Apple Inc., USA.
- SVGA, XGA, SXGA and UXGA are registered trademarks of the Video Electronics Standard Association.
Even if no special notation has been made of company or product trademarks, these trademarks have been fully respected.
- HDMI, the HDMI Logo, and High-Definition Multimedia Interface are trademarks or registered trademarks of HDMI Licensing LLC in the United States and other countries.

Note:

Do not allow a still picture to be displayed for an extended period, as this can cause a permanent image retention to remain on the Plasma Display.

Examples of still pictures include logos, video games, computer images, teletext and images displayed in 4:3 mode.

Safety Precautions

WARNING

■ Setup

This Plasma Display is for use only with the following optional accessories. Use with any other type of optional accessories may cause instability which could result in the possibility of injury.

(All of the following accessories are manufactured by Panasonic Corporation.)

- Speakers TY-SP42P8W-K (for TH-42PF30ER),
TY-SP50P8W-K (for TH-50PF30ER)
- Pedestal TY-ST20-K
- Mobile stand TY-ST58PF20
- Wall-hanging bracket (vertical) TY-WK42PV20
- Wall-hanging bracket (angled) TY-WK42PR20
- Ceiling-hanging bracket TY-CE42PS20
- BNC Dual Video Terminal Board TY-FB9BD
- HD-SDI Terminal Board with audio TY-FB10HD
- Dual Link HD-SDI Terminal Board TY-FB11DHD
- Dual HD-SDI Terminal Board for 3D TY-FB30DHD3D
- Dual HDMI Terminal Board TY-FB10HMD
- Ir Through Terminal Board TY-FB9RT
- DVI-D Terminal Board TY-FB11DD
- Dual DVI-D Terminal Board for 3D TY-FB30DD3D
- AV Terminal Box TY-TB10AV
- 3D IR TRANSMITTER TY-3D30TRW
- Touch Panel TY-TP42P10S (for TH-42PF30ER),
TY-TP50P10S (for TH-50PF30ER)

Always be sure to ask a qualified technician to carry out set-up.

Small parts can present choking hazard if accidentally swallowed. Keep small parts away from young children. Discard unneeded small parts and other objects, including packaging materials and plastic bags/sheets to prevent them from being played with by young children, creating the potential risk of suffocation.

Do not place the Plasma Display on sloped or unstable surfaces, and ensure that the Plasma Display does not hang over the edge of the base.

- The Plasma Display may fall off or tip over.

Do not place any objects on top of the Plasma Display.

- If water is spilled onto the Plasma Display or foreign objects get inside it, a short-circuit may occur which could result in fire or electric shock. If any foreign objects get inside the Plasma Display, please consult your local Panasonic dealer.

Transport only in upright position!

- Transporting the unit with its display panel facing upright or downward may cause damage to the internal circuitry.

Ventilation should not be impeded by covering the ventilation openings with items such as newspapers, table cloths and curtains.

For sufficient ventilation;

If using the pedestal (optional accessory), leave a space of 10 cm or more at the top, left and right, and 7 cm or more at the rear, and also keep the space between the bottom of the display and the floor surface.

If using some other setting-up method, follow the manual of it. (If there is no specific indication of installation dimension in the installation manual, leave a space of 10 cm or more at the top, bottom, left and right, and 7 cm or more at the rear.)

When installing the Plasma Display vertically;

Turn up the power switch for the upward direction when you install the Plasma Display vertically. And set "Display orientation" to "Portrait" in Setup menu. (see page 43)

■ When using the Plasma Display

The Plasma Display is designed to operate on 220 - 240 V AC, 50/60 Hz.

Do not cover the ventilation holes.

- Doing so may cause the Plasma Display to overheat, which can cause fire or damage to the Plasma Display.

Do not stick any foreign objects into the Plasma Display.

- Do not insert any metal or flammable objects into the ventilations holes or drop them onto the Plasma Display, as doing so can cause fire or electric shock.

Do not remove the cover or modify it in any way.

- High voltages which can cause severe electric shocks are present inside the Plasma Display. For any inspection, adjustment and repair work, please contact your local Panasonic dealer.

Ensure that the mains plug is easily accessible.

An apparatus with CLASS I construction shall be connected to a mains socket outlet with a protective earthing connection.

Do not use any power supply cord other than that provided with this unit.

- Doing so may cause fire or electric shocks.

Securely insert the power supply plug as far as it will go.

- If the plug is not fully inserted, heat may be generated which could cause fire. If the plug is damaged or the wall socket is loose, they shall not be used.

Do not handle the power supply plug with wet hands.

- Doing so may cause electric shocks.

Do not do anything that may damage the power cable. When disconnecting the power cable, pull on the plug body, not the cable.

- Do not damage the cable, make any modifications to it, place heavy objects on top of it, heat it, place it near any hot objects, twist it, bend it excessively or pull it. To do so may cause fire and electric shock. If the power cable is damaged, have it repaired at your local Panasonic dealer.

If the Plasma Display is not going to be used for any prolonged length of time, unplug the power supply plug from the wall outlet.

To prevent the spread of fire, keep candles or other open flames away from this product at all times.



■ If problems occur during use

If a problem occurs (such as no picture or no sound), or if smoke or an abnormal odour starts to come out from the Plasma Display, immediately unplug the power supply plug from the wall outlet.

- If you continue to use the Plasma Display in this condition, fire or electric shock could result. After checking that the smoke has stopped, contact your local Panasonic dealer so that the necessary repairs can be made. Repairing the Plasma Display yourself is extremely dangerous, and shall never be done.

If water or foreign objects get inside the Plasma Display, if the Plasma Display is dropped, or if the cabinet becomes damages, disconnect the power supply plug immediately.

- A short circuit may occur, which could cause fire. Contact your local Panasonic dealer for any repairs that need to be made.

Safety Precautions

CAUTION

■ When using the Plasma Display

Do not bring your hands, face or objects close to the ventilation holes of the Plasma Display.

- Heated air comes out from the ventilation holes at the top of Plasma Display will be hot. Do not bring your hands or face, or objects which cannot withstand heat, close to this port, otherwise burns or deformation could result.

Be sure to disconnect all cables before moving the Plasma Display.

- If the Plasma Display is moved while some of the cables are still connected, the cables may become damaged, and fire or electric shock could result.

Disconnect the power supply plug from the wall socket as a safety precaution before carrying out any cleaning.

- Electric shocks can result if this is not done.

Clean the power cable regularly to prevent it becoming dusty.

- If dust built up on the power cord plug, the resultant humidity can damage the insulation, which could result in fire. Pull the power cord plug out from the wall outlet and wipe the mains lead with a dry cloth.

Do not burn or breakup batteries.

- Batteries must not be exposed to excessive heat such as sunshine, fire or the like.

This Plasma Display radiates infrared rays, therefore it may affect other infrared communication equipment. Install your infrared sensor in a place away from direct or reflected light from your Plasma Display.

Cleaning and maintenance

The front of the display panel has been specially treated. Wipe the panel surface gently using only a cleaning cloth or a soft, lint-free cloth.

- If the surface is particularly dirty, wipe with a soft, lint-free cloth which has been soaked in pure water or water in which neutral detergent has been diluted 100 times, and then wipe it evenly with a dry cloth of the same type until the surface is dry.
- Do not scratch or hit the surface of the panel with fingernails or other hard objects, otherwise the surface may become damaged. Furthermore, avoid contact with volatile substances such as insect sprays, solvents and thinner, otherwise the quality of the surface may be adversely affected.

If the cabinet becomes dirty, wipe it with a soft, dry cloth.

- If the cabinet is particularly dirty, soak the cloth in water to which a small amount of neutral detergent has been added and then wring the cloth dry. Use this cloth to wipe the cabinet, and then wipe it dry with a dry cloth.
- Do not allow any detergent to come into direct contact with the surface of the Plasma Display. If water droplets get inside the unit, operating problems may result.
- Avoid contact with volatile substances such as insect sprays, solvents and thinner, otherwise the quality of the cabinet surface may be adversely affected or the coating may peel off. Furthermore, do not leave it for long periods in contact with articles made from rubber or PVC.

3D Safety Precautions

WARNING

■ Small Parts

3D Eyewear contains small parts (battery and specialised band, etc.) and must be kept out of reach of small children to avoid accidental ingestion.

■ Disassembly

Do not disassemble or modify the 3D Eyewear.

■ Lithium Battery

Batteries must not be exposed to excessive heat such as sunshine, fire or the like.



CAUTION

To enjoy 3D images safely and comfortably, please read these instructions fully.

■ Use for commercial applications and public viewing

Someone in authority should responsibly convey the precautions for use of the 3D Eyewear to the user.

■ 3D Eyewear

Do not drop, exert pressure on, or step on the 3D Eyewear.

Always store the 3D Eyewear in the case provided when not in use.

Be careful of the tips of the frame when putting on the 3D Eyewear.

Be careful not to trap a finger in the hinge section of the 3D Eyewear.

Pay special attention when children are using the 3D Eyewear.

3D Eyewear should not be used by children younger than 5 - 6 years old, as a guideline.

All children must be fully supervised by parents or guardians who must ensure their safety and health throughout the using 3D Eyewear.

Safety Precautions

■ Viewing 3D Content

Content for 3D viewing includes commercially available Blu-ray discs, 3D broadcasts, etc. When preparing your own 3D content, ensure that it is properly produced.

Do not use the 3D Eyewear if you have a history of over-sensitivity to light, heart problems, or have any other existing medical conditions.

Please stop using the 3D Eyewear immediately, if you feel tired, are not feeling well or experience any other uncomfortable sensation.

Take an appropriate break after viewing a 3D movie.

Take a break of between 30 - 60 minutes after viewing 3D content on interactive devices such as 3D games or computers.

Be careful not to strike the screen or other people unintentionally. When using the 3D Eyewear the distance between the user and screen can be misjudged.

The 3D Eyewear must only be worn when viewing 3D content.

If you do not look toward the screen for a while when viewing 3D images, the 3D Eyewear may be turned off automatically.

If you suffer from any eyesight problems (short / far-sighted, astigmatism, eyesight differences in left and right), please ensure to correct your vision before using the 3D Eyewear.

Stop using the 3D Eyewear if you can clearly see double images when viewing 3D content.

Do not use the 3D Eyewear at a distance less than the recommended distance.

View from at least the recommended distance (3 times the effective height of the screen).

Recommended distance

TH-42PF30ER: 1.6 m

TH-50PF30ER: 1.9 m

When the top and bottom area of the screen is blackened, such as movies, view the screen at a distance 3 times further than the height of the actual image. (That makes the distance closer than above recommended figure.)

■ 3D Eyewear Use

Before using the 3D Eyewear, ensure no breakable objects surrounding the user to avoid any accidental damage or injury.

Remove the 3D Eyewear before moving around to avoid falling or accidental injury.

Always put the 3D Eyewear in the case (supplied) after use.

Use the 3D Eyewear only for the intended purpose and nothing else.

Do not use 3D Eyewear in the condition of high temperature.

Do not use if the 3D Eyewear is physically damaged.

Do not use any devices that emit the infrared signals near the 3D Eyewear, as this may cause the 3D Eyewear false operations.

Do not use devices (such as mobile phones or personal transceivers) that emit strong electromagnetic waves near the 3D Eyewear as this may cause the 3D Eyewear to malfunction.

Stop using the 3D Eyewear immediately if a malfunction or fault occurs.

Stop using the 3D Eyewear immediately if you experience any redness, pain, or skin irritation around the nose or temples.

In rare cases, the materials used in the 3D Eyewear may cause an allergic reaction.

■ Lithium Battery

Danger of explosion if battery is incorrectly replaced. Replace only with the same or equivalent type.

Accessories

Accessories Supply

Check that you have the accessories and items shown



Operating Instruction book

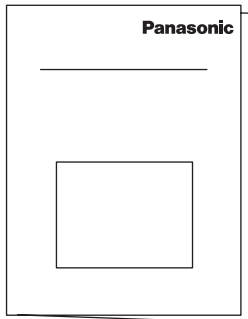

CD-ROM
(Operating instructions)

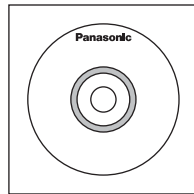

Remote Control
Transmitter
N2QAYB000535

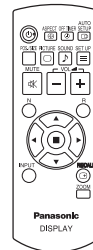

Batteries for the Remote
Control Transmitter
(R6 (UM3) Size × 2)

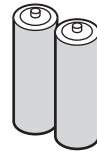

Power supply cord

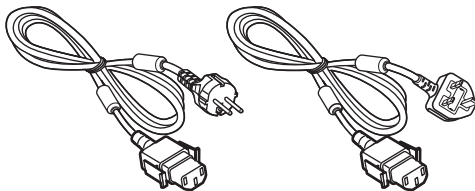

Clamper × 1
TMME289

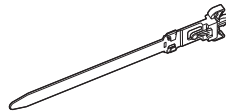

Ferrite core × 2
J0KG00000014

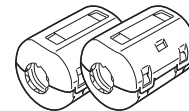

Use the Ferrite cores to comply with the EMC standard.
(see page 60)

Remote Control Batteries

Requires two R6 batteries.

1. Pull and hold the hook, then open the battery cover.
2. Insert batteries - note correct polarity (+ and -).
3. Replace the cover.

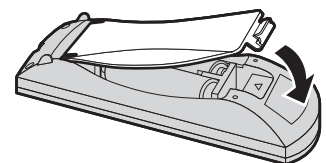
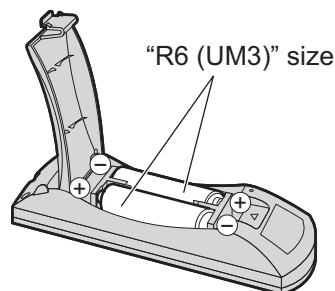
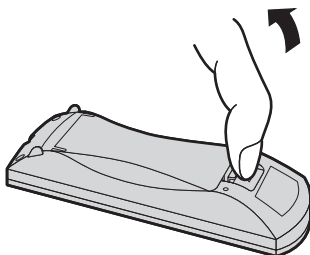

Helpful Hint:

For frequent remote control users, replace old batteries with Alkaline batteries for longer life.

⚠ Precaution on battery use

Incorrect installation can cause battery leakage and corrosion that will damage the remote control transmitter. Disposal of batteries should be in an environment-friendly manner.

Observe the following precaution:

1. Batteries shall always be replaced as a pair. Always use new batteries when replacing the old set.
2. Do not combine a used battery with a new one.
3. Do not mix battery types (example: "Zinc Carbon" with "Alkaline").
4. Do not attempt to charge, short-circuit, disassemble, heat or burn used batteries.
5. Battery replacement is necessary when remote control acts sporadically or stops operating the Plasma Display set.
6. Do not burn or breakup batteries.
Batteries must not be exposed to excessive heat such as sunshine, fire or the like.

Connections

Speaker connection

When connecting the speakers, be sure to use only the optional accessory speakers. Refer to the speaker's Installation Manual for details on speaker installation.

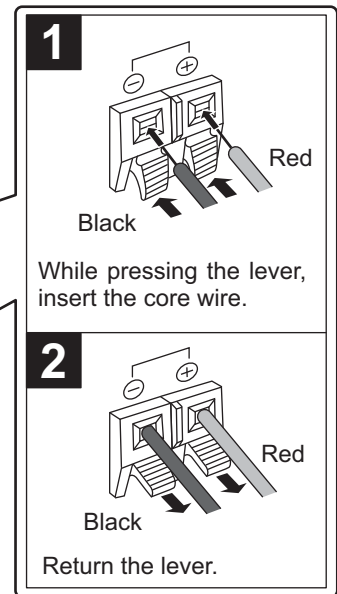
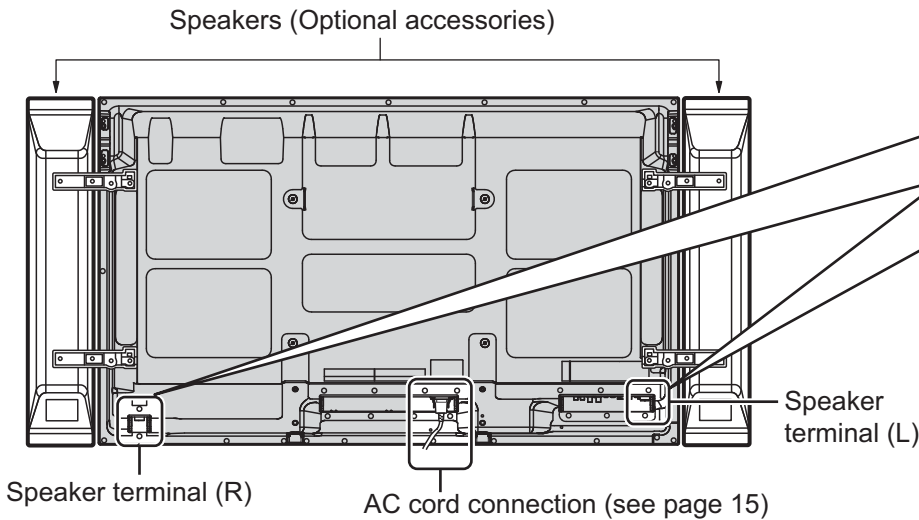

AC cord connection and fixing, cable fixing

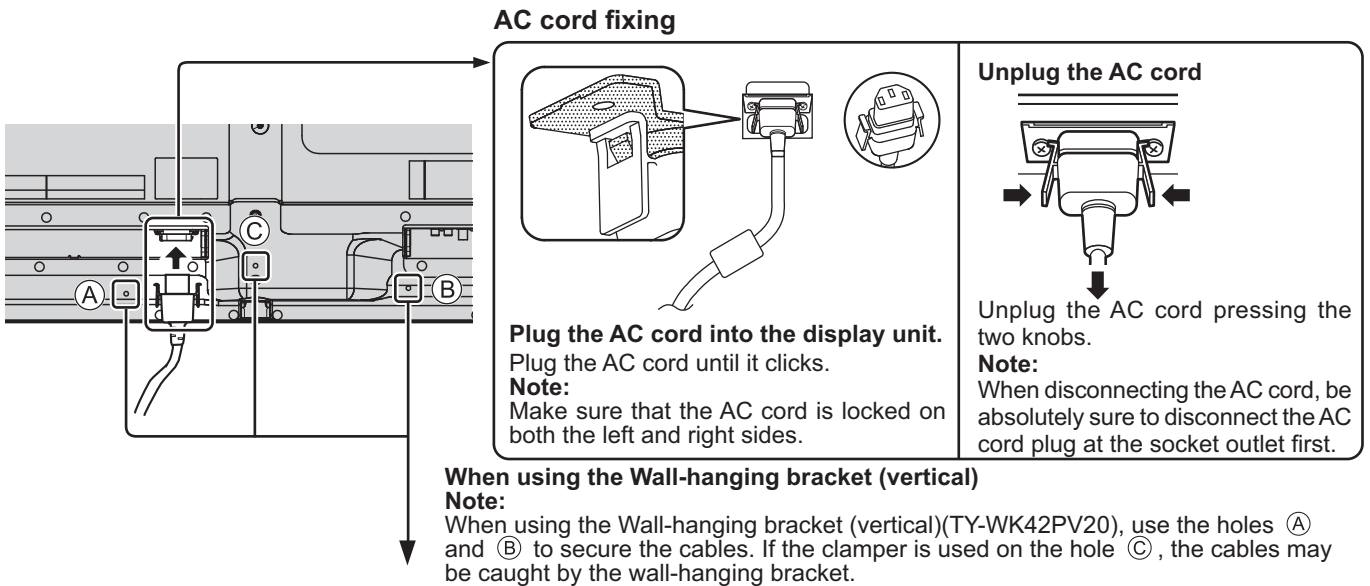

Using the clammer

Secure any excess cables with clammer as required.

Note:

One clammer is supplied with this unit. In case of securing cables at three positions, please purchase it separately.

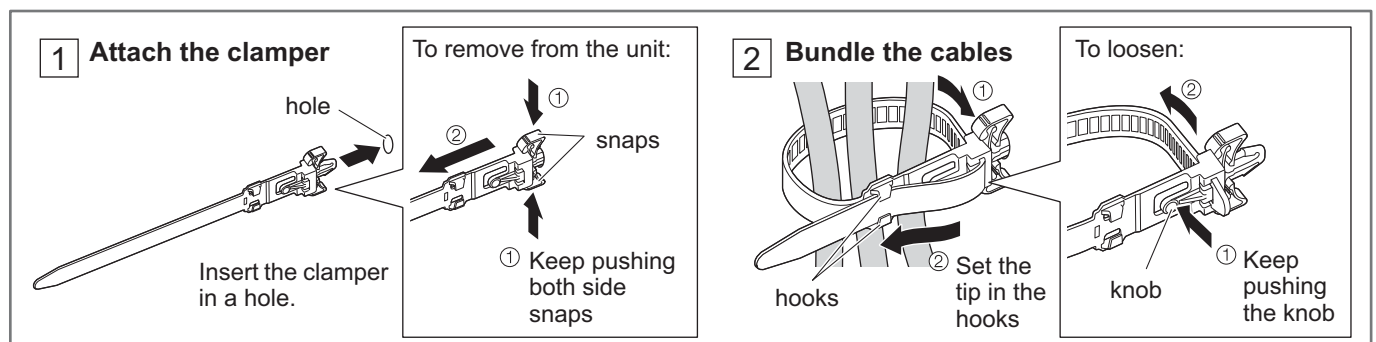

Video equipment connection

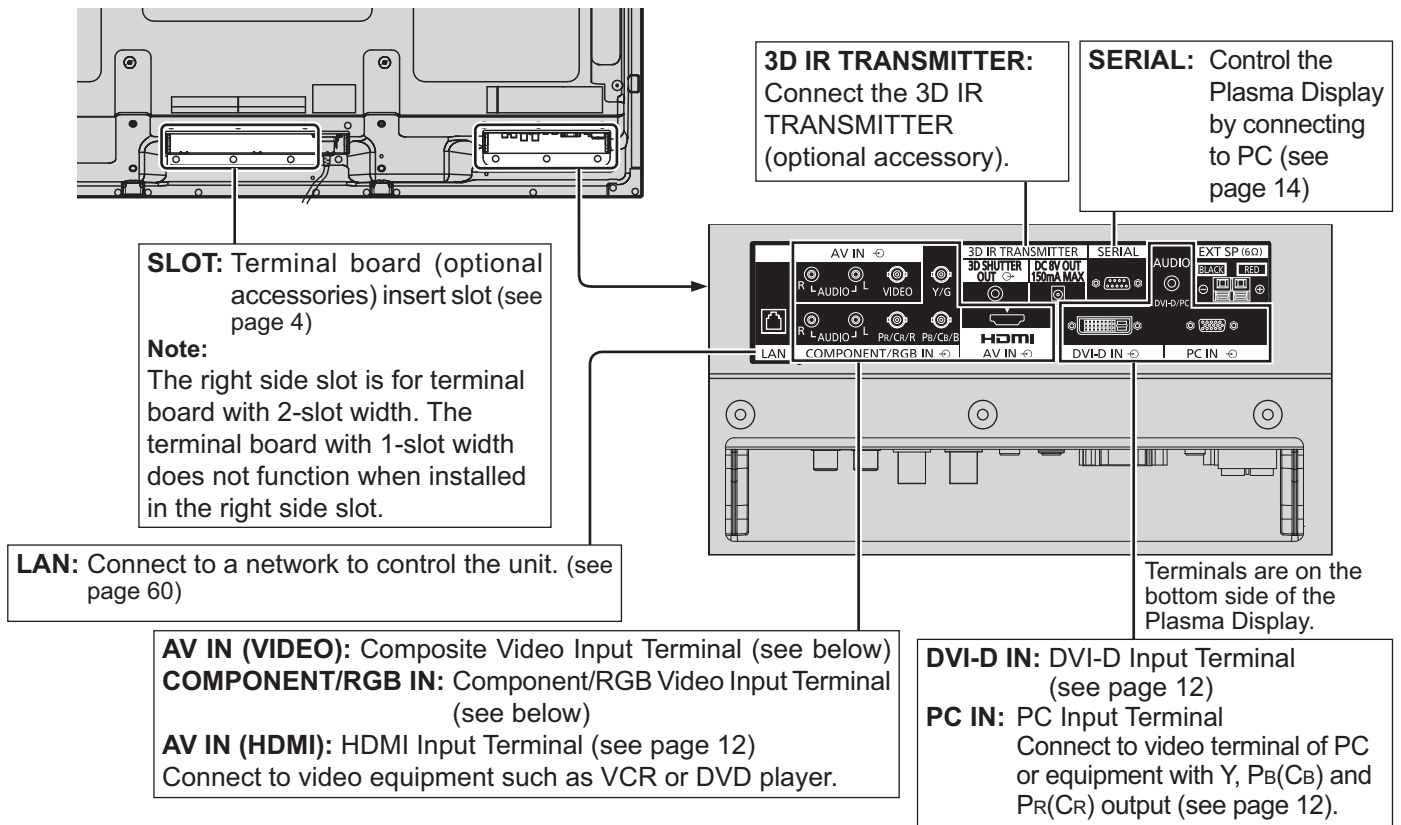

VIDEO and COMPONENT / RGB IN connection

Note:

Additional equipment, cables and adapter plugs shown are not supplied with this set.

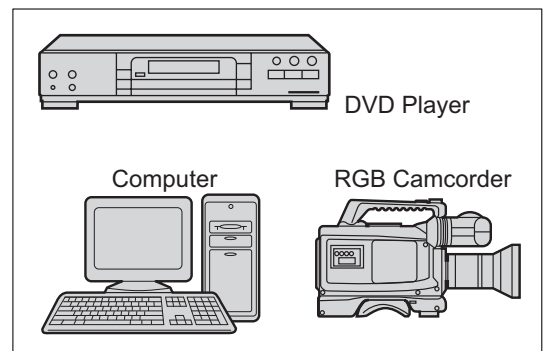
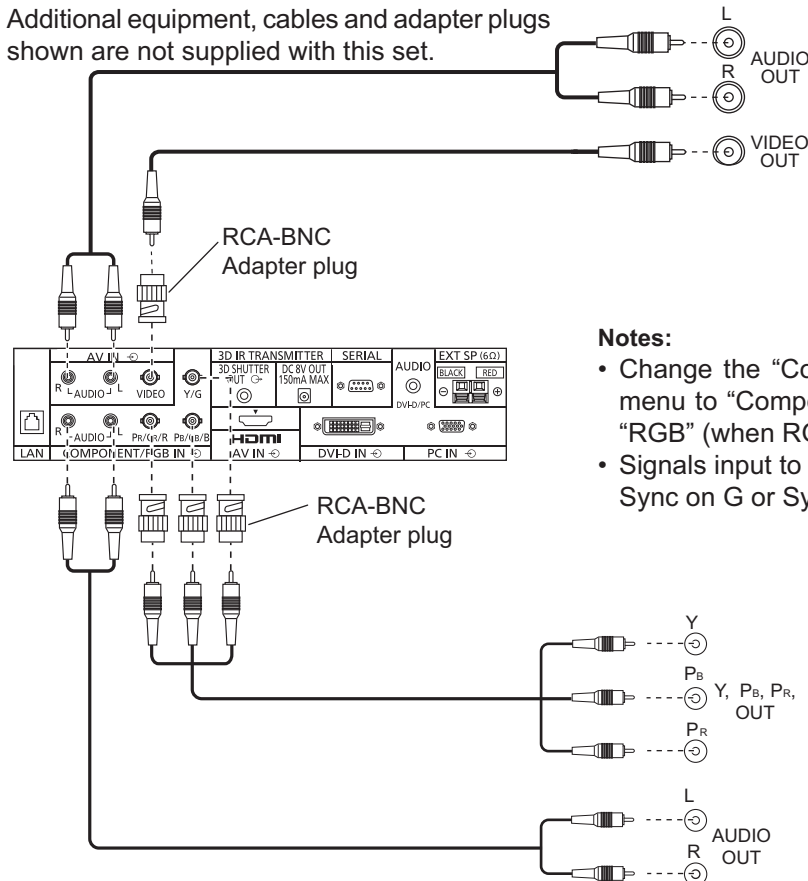

HDMI connection

[Pin assignments and signal names]

| Pin No. | Signal name | Pin No. | Signal name |
|---------|----------------------|---------|---------------------------|
| ① | T.M.D.S Data2+ | ⑪ | T.M.D.S Clock Shield |
| ② | T.M.D.S Data2 Shield | ⑫ | T.M.D.S Clock- |
| ③ | T.M.D.S Data2- | ⑬ | CEC |
| ④ | T.M.D.S Data1+ | ⑭ | Reserved (N.C. on device) |
| ⑤ | T.M.D.S Data1 Shield | | |
| ⑥ | T.M.D.S Data1- | ⑮ | SCL |
| ⑦ | T.M.D.S Data0+ | ⑯ | SDA |
| ⑧ | T.M.D.S Data0 Shield | ⑰ | DDC/CEC Ground |
| ⑨ | T.M.D.S Data0- | ⑱ | +5V Power |
| ⑩ | T.M.D.S Clock+ | ⑲ | Hot Plug Detect |

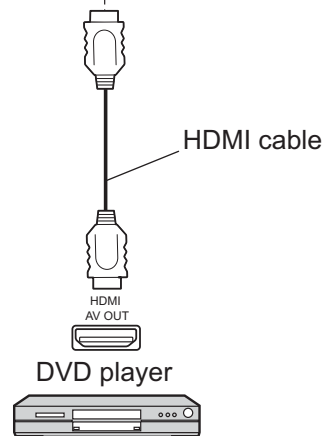
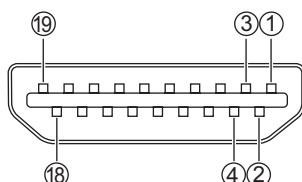
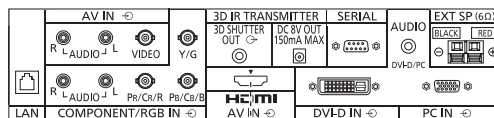

Note:

Additional equipment and HDMI cable shown are not supplied with this set.

DVI-D IN connection

PC with DVI-D video out



DVI-video cable (Within 5 m)

Stereo mini plug (M3)

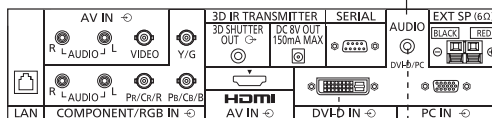

DVI-D Input Connector Pin Layouts

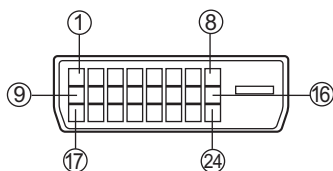

Connection port view

| Pin No. | Signal Name | Pin No. | Signal Name |
|---------|------------------------|---------|------------------------|
| ① | T.M.D.S. data 2- | ⑬ | _____ |
| ② | T.M.D.S. data 2+ | ⑭ | +5 V DC |
| ③ | T.M.D.S. data 2 shield | ⑮ | Ground |
| ④ | _____ | ⑯ | Hot plug detect |
| ⑤ | _____ | ⑰ | T.M.D.S. data 0- |
| ⑥ | DDC clock | ⑱ | T.M.D.S. data 0+ |
| ⑦ | DDC data | ⑲ | T.M.D.S. data 0 shield |
| ⑧ | _____ | ⑳ | _____ |
| ⑨ | T.M.D.S. data 1- | ㉑ | _____ |
| ⑩ | T.M.D.S. data 1+ | ㉒ | T.M.D.S. clock shield |
| ⑪ | T.M.D.S. data 1 shield | ㉓ | T.M.D.S. clock+ |
| ⑫ | _____ | ㉔ | T.M.D.S. clock- |

Notes:

- Additional equipment and cables shown are not supplied with this set.
- Use the DVI-D cable complying with the DVI standard. Image deterioration may occur depending on the length or the quality of the cable.

PC Input Terminals connection

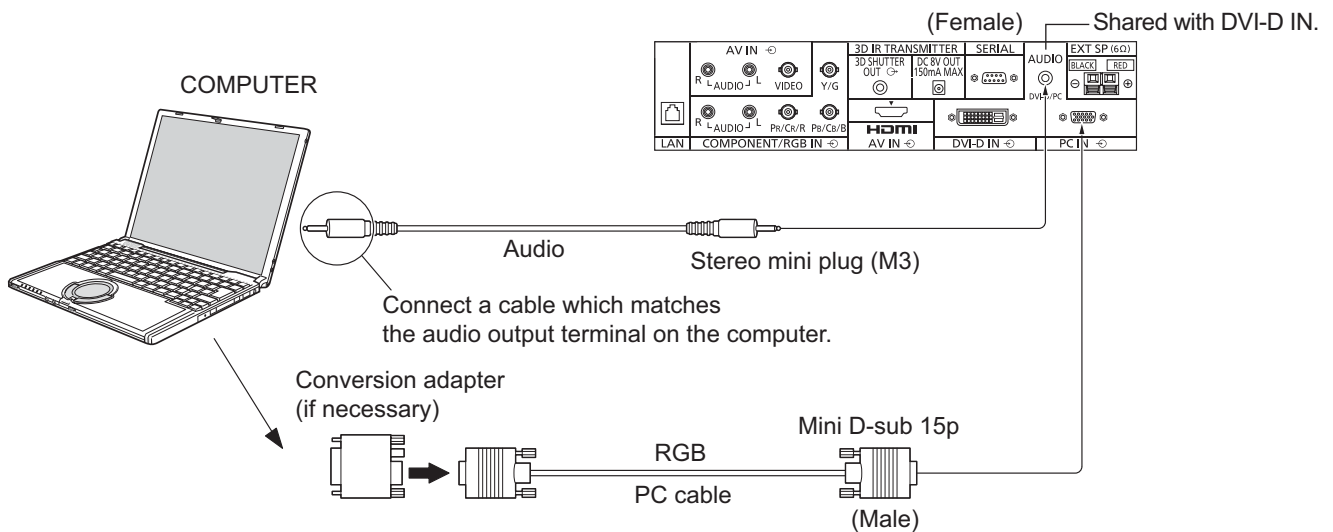

Notes:

- With regard to the typical PC input signals that are described in the applicable input signals list (see page 67), adjustment values such as for the standard picture positions and sizes have already been stored in this unit. You can add up to eight PC input signal types that are not included in the list.
- Computer signals which can be input are those with a horizontal scanning frequency of 15 to 110 kHz and vertical scanning frequency of 48 to 120 Hz. (However, the image will not be displayed properly if the signals exceed 1,200 lines.)
- The display resolution is a maximum of 1,440 × 1,080 dots when the aspect mode is set to “4:3”, and 1,920 × 1,080 dots when the aspect mode is set to “16:9”. If the display resolution exceeds these maximums, it may not be possible to show fine detail with sufficient clarity.
- The PC input terminals are DDC2B-compatible. If the computer being connected is not DDC2B-compatible, you will need to make setting changes to the computer at the time of connection.
- Some PC models cannot be connected to the set.
- There is no need to use an adapter for computers with DOS/V compatible Mini D-sub 15P terminal.
- The computer shown in the illustration is for example purposes only.
- Additional equipment and cables shown are not supplied with this set.
- Do not set the horizontal and vertical scanning frequencies for PC signals which are above or below the specified frequency range.
- Component Input is possible with the pin 1, 2, 3 of the Mini D-sub 15P Connector.
- To use sync input VBS signals, use the connector which incorporates a 75-ohm termination resistance and which is available on the market, for the connection of the HD connector where the VBS signals are to be input.
- Change the “Component/RGB-in select” setting in the “Setup” menu to “Component” (when Component signal connection) or “RGB” (when RGB signal connection). (see page 48)

Signal Names for Mini D-sub 15P Connector

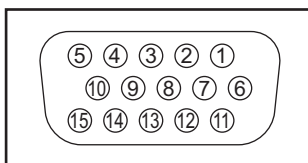

| Pin No. | Signal Name | Pin No. | Signal Name | Pin No. | Signal Name |
|---------|-------------------------------------|---------|--------------|---------|--------------------|
| ① | R (P _R /C _R) | ⑥ | GND (Ground) | ⑪ | NC (not connected) |
| ② | G (Y) | ⑦ | GND (Ground) | ⑫ | SDA |
| ③ | B (P _B /C _B) | ⑧ | GND (Ground) | ⑬ | HD/SYNC |
| ④ | NC (not connected) | ⑨ | +5 V DC | ⑭ | VD |
| ⑤ | GND (Ground) | ⑩ | GND (Ground) | ⑮ | SCL |

Pin Layout for PC Input Terminal

SERIAL Terminals connection

The SERIAL terminal is used when the Plasma Display is controlled by a computer.

Note: To use serial control for this unit, make sure to set the “Control I/F Select” in the “Network Setup” menu to “RS-232C”. (see page 52)

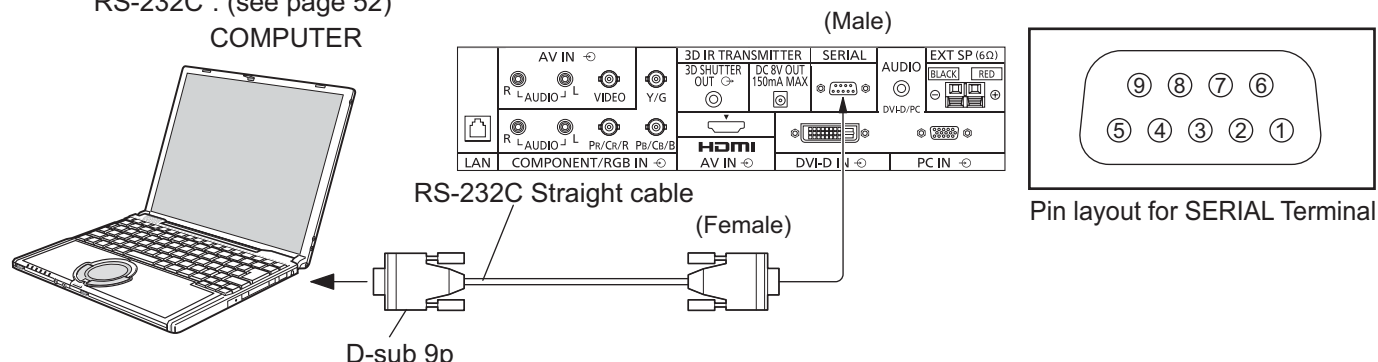

Notes:

- Use the RS-232C straight cable to connect the computer to the Plasma Display.
- The computer shown is for example purposes only.
- Additional equipment and cables shown are not supplied with this set.

The SERIAL terminal conforms to the RS-232C interface specification, so that the Plasma Display can be controlled by a computer which is connected to this terminal.

The computer will require software which allows the sending and receiving of control data which satisfies the conditions given below. Use a computer application such as programming language software. Refer to the documentation for the computer application for details.

Communication parameters

| | |
|------------------------|-------------------|
| Signal level | RS-232C compliant |
| Synchronization method | Asynchronous |
| Baud rate | 9600 bps |
| Parity | None |
| Character length | 8 bits |
| Stop bit | 1 bit |
| Flow control | - |

Basic format for control data

The transmission of control data from the computer starts with a STX signal, followed by the command, the parameters, and lastly an ETX signal in that order. If there are no parameters, then the parameter signal does not need to be sent.

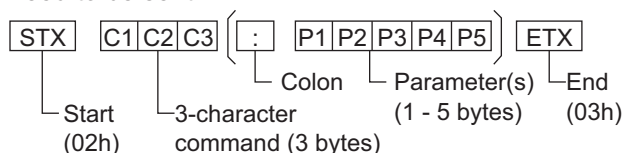

Notes:

- If multiple commands are transmitted, be sure to wait for the response for the first command to come from this unit before sending the next command.
- If an incorrect command is sent by mistake, this unit will send an “ER401” command back to the computer.
- S1A and S1B of Command IMS are available only when a dual input terminal board is attached.

Signal names for D-sub 9P connector

| Pin No. | Details |
|---------|-----------------------|
| ② | R X D |
| ③ | T X D |
| ⑤ | GND |
| ④ • ⑥ | Non use |
| ⑦ ⑧ | (Shorted in this set) |
| ① • ⑨ | NC |

These signal names are those of computer specifications.

Command

| Command | Parameter | Control details |
|---------|----------------------|---|
| PON | None | Power ON |
| POF | None | Power OFF |
| AVL | ** | Volume 00 - 63 |
| AMT | 0 | Audio MUTE OFF |
| | 1 | Audio MUTE ON |
| IMS | None | Input select (toggle) |
| | SL1 | SLOT input (SLOT INPUT) |
| | S1A | SLOT input (SLOT INPUT A) |
| | S1B | SLOT input (SLOT INPUT B) |
| | VD1 | VIDEO input (VIDEO) |
| | YP1 | COMPONENT/RGB IN input (COMPONENT) |
| | HM1 | HDMI input (HDMI) |
| DV1 | DVI-D IN input (DVI) | |
| | PC1 | PC IN input (PC) |
| DAM | None | Screen mode select (toggle) |
| | ZOOM | Zoom1 (For Video/SD/PC signal) 16:9 |
| | FULL | Just (For Video/SD signal) 4:3 (For Video/SD/PC signal) |
| | JUST | Zoom2 (For HD signal) |
| | NORM | Zoom3 (For HD signal) |
| | ZOM2 | Just (For HD signal) |
| | ZOM3 | 4:3 (For HD signal) |
| | SJST | 4:3 Full (For HD signal) |
| | SNOM | 14:9 |
| | SFUL | |
| 14:9 | | |

With the power off, this display responds to PON command only.

Power On / Off

Connecting the AC cord plug to the Plasma Display.

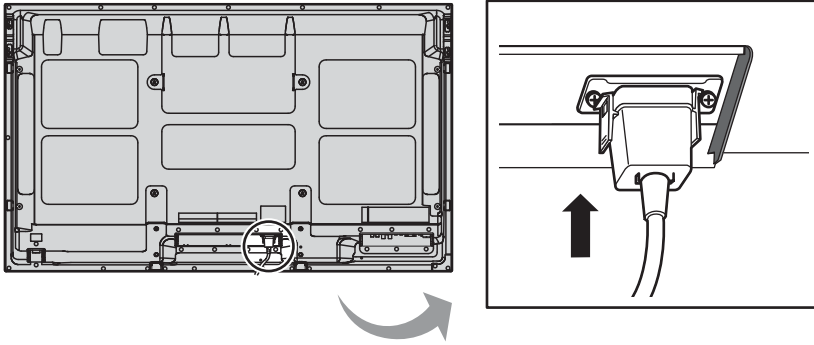

Connecting the plug to the Wall Outlet

Notes:

- Main plug types vary between countries. The power plug shown at right may, therefore, not be the type fitted to your set.
- When disconnecting the AC cord, be absolutely sure to disconnect the AC cord plug at the socket outlet first.

Press the Power switch on the Plasma Display to turn the set on: Power-On.

Power Indicator: Green

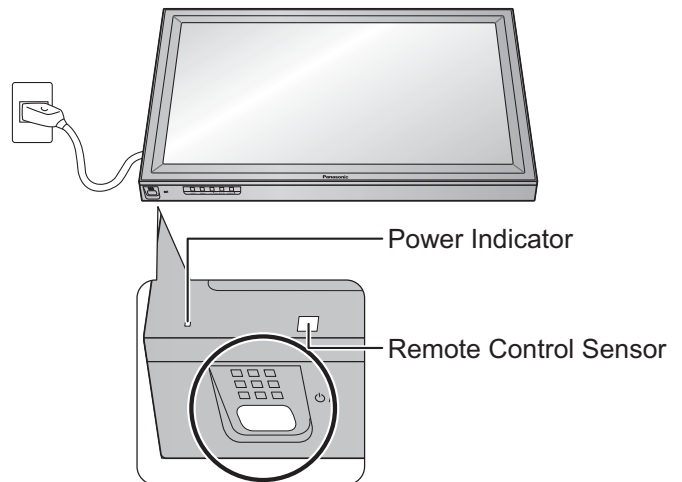

Press the  button on the remote control to turn the Plasma Display off.

Power Indicator: Red (standby)

Press the  button on the remote control to turn the Plasma Display on.

Power Indicator: Green

Turn the power to the Plasma Display off by pressing the /I switch on the unit, when the Plasma Display is on or in standby mode.

Note:

During operation of the power management function, the power indicator turns orange in the power off state.

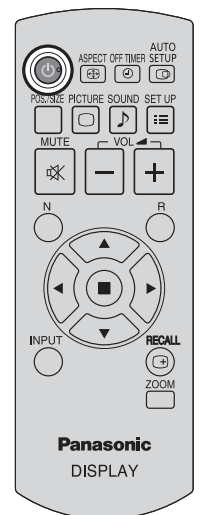

When first switching on the unit

Following screen will be displayed when the unit is turned on for the first time. Select the items with the remote control. Unit buttons are invalid.

OSD Language

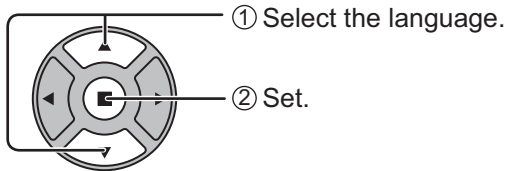

PRESENT TIME Setup

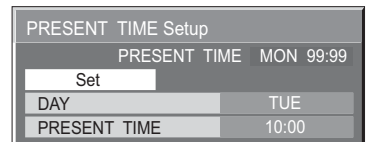
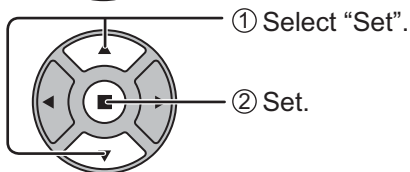
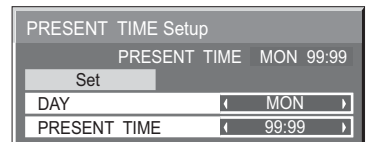
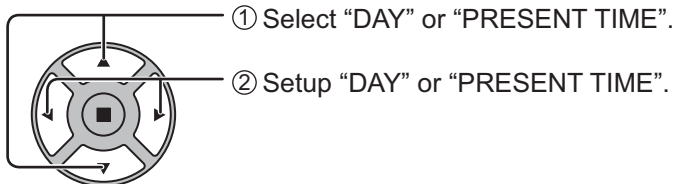

No activity power off

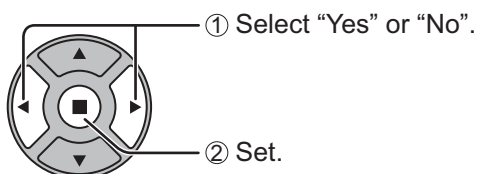
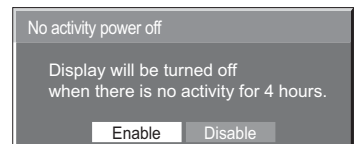
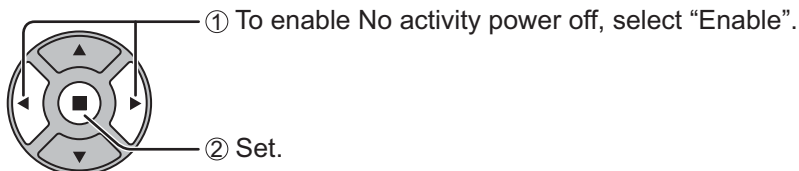

If selecting "Enable", a confirmation window appears.

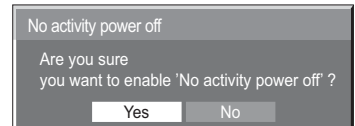

Display orientation

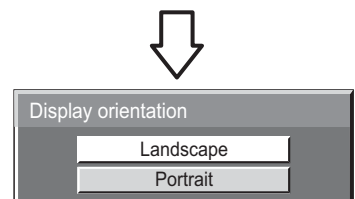
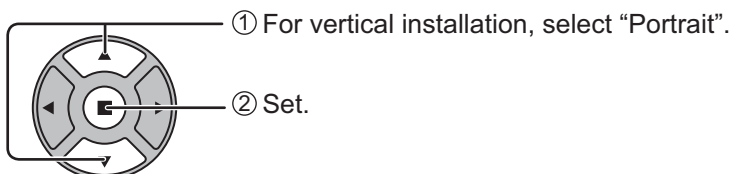

Notes:

- Once the items are set, the screens won't be displayed when switching on the unit next time.
- After the setting, the items can be changed in the following menus.
OSD Language (see page 43)
PRESENT TIME Setup (see page 34)
No activity power off (see page 41)
Display orientation (see page 43)

Power ON warning message

The following message may be displayed when turning the unit power ON:

3D Safety Precautions

When 3D images will be viewed by unspecified number of people or used for commercial applications, someone in authority should convey the following precautions. These precautions should be followed in the home as well.

3D Viewing/ 3D Content/ Viewing distance/ 3D Eyewear recommendations
 - To enjoy 3D images safely and comfortably, please read the Operating Instructions fully.

Activate 3D Safety Precautions if you deliver 3D images to unspecified audiences for business or other purposes. If "3D Picture Display" in "3D Settings" is set to "3D", a warning message is displayed every time the power is turned ON. (see page 35)

No activity power off Precautions

'No activity power off' is enabled.

If "No activity power off" in Setup menu is set to "Enable", a warning message is displayed every time the power is turned ON. (see page 41)

These message displays can be set with the following menu: Options menu
 3D Safety Precautions (see page 56)
 Power On Message (see page 55)

Selecting the input signal

INPUT



Press to select the input signal to be played back from the equipment which has been connected to the Plasma Display.

Input signals will change as follows:

→ PC → VIDEO → COMPONENT* → HDMI → DVI →

- PC: PC input terminal in PC IN.
- VIDEO: Video input terminal in AV IN (VIDEO).
- COMPONENT*: Component or RGB input terminal in COMPONENT/RGB IN.
- HDMI: HDMI input terminal in AV IN (HDMI).
- DVI: DVI input terminal in DVI-D IN.
- * "COMPONENT" may be displayed as "RGB" depending on the setting of "Component/RGB-in select". (see page 48)

When an optional Terminal Board is installed:

→ PC → SLOT INPUT → VIDEO → COMPONENT → HDMI → DVI →

SLOT INPUT: Input terminal in Terminal Board

Note:

When a Terminal Board incompatible with the Plasma Display is installed, "Non-Compatible Function Board" is displayed.

When a Terminal Board with dual input terminals is installed:

→ PC → SLOT INPUT A → SLOT INPUT B → VIDEO → COMPONENT → HDMI → DVI →

SLOT INPUT A, SLOT INPUT B: Dual input terminal in Terminal Board.

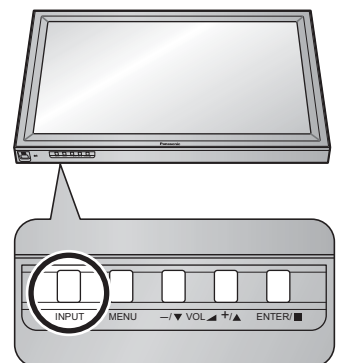
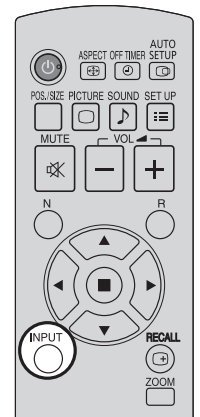

Notes:

- Selecting is also possible by pressing the INPUT button on the unit.
- Outputs the sound as set in "Audio input select" in the Options menu. (see page 58)
- Select to match the signals from the source connected to the component/RGB input terminals. (see page 48)
- Image retention (image lag) may occur on the plasma display panel when a still picture is kept on the panel for an extended period. The function that darkens the screen slightly is activated to prevent image retention (see page 65), but this function is not the perfect solution to image retention.

Basic Controls

Main Unit

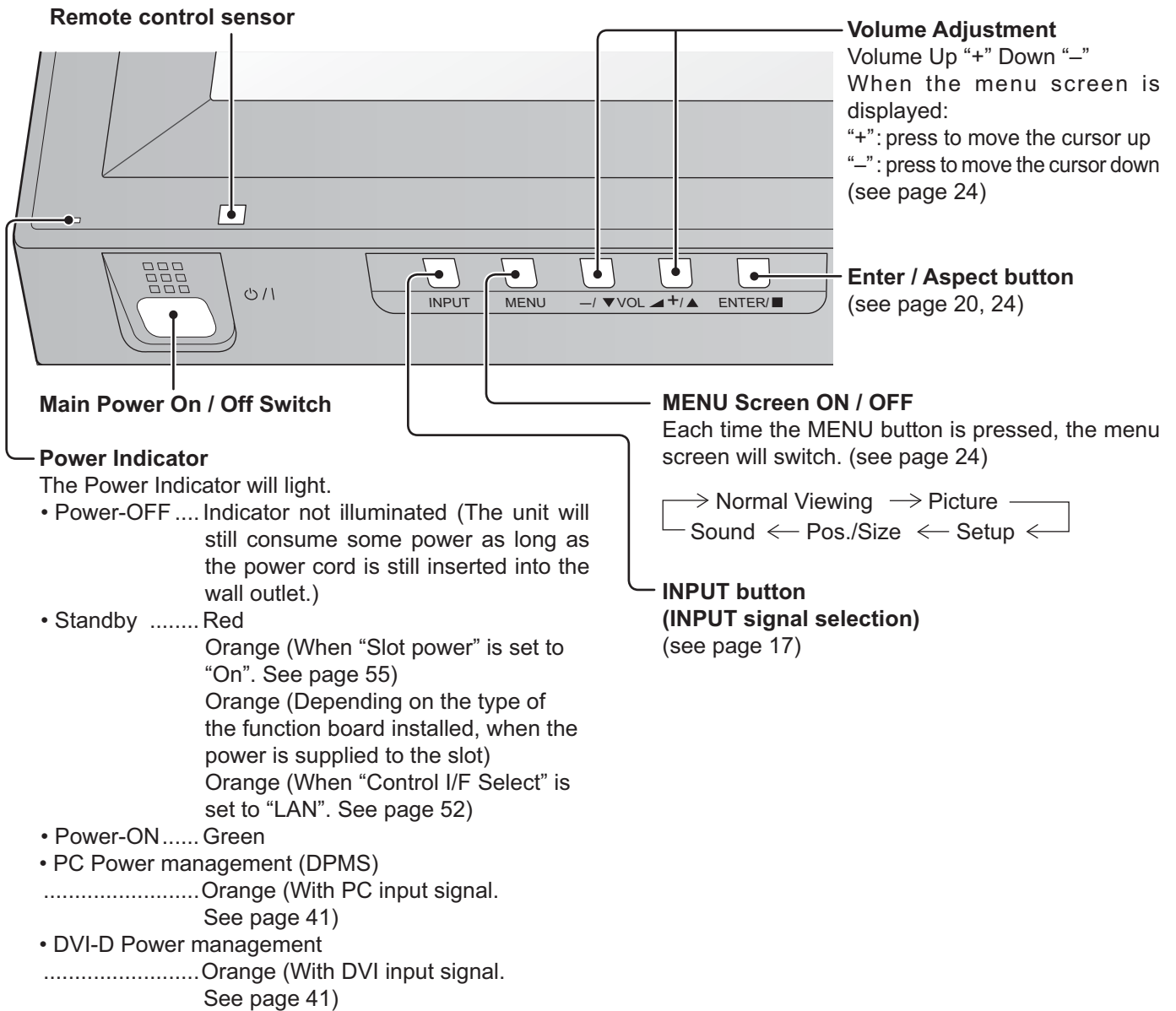

Remote Control Transmitter

ACTION button

Press to make selections.

ASPECT button

Press to adjust the aspect.
(see page 20)

Standby (ON / OFF) button

The Plasma Display must first be plugged into the wall outlet and turned on at the power switch (see page 15). Press this button to turn the Plasma Display On, from Standby mode. Press it again to turn the Plasma Display Off to Standby mode.

POS./SIZE button

(see page 25)

PICTURE button

(see page 28)

Sound mute On / Off

Press this button to mute the sound.
Press again to reactivate sound.
Sound is also reactivated when power is turned off or volume level is changed.

N button

(see page 27, 28, 29, 33)

POSITION buttons

INPUT button

Press to select Input signal sequentially. (see page 17)

OFF TIMER button

The Plasma Display can be preset to switch to stand-by after a fixed period. The setting changes to 30 minutes, 60 minutes, 90 minutes and 0 minutes (off timer cancelled) each time the button is pressed.

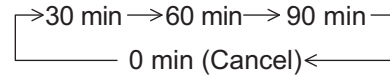

When three minutes remain, "Off timer 3 min" will flash.

The off timer is cancelled if a power interruption occurs.

AUTO SETUP button

Automatically adjusts the position/size of the screen. (see page 25)

SET UP button

(see page 24)

SOUND button

(see page 33)

Volume Adjustment

Press the Volume Up "+" or Down "-" button to increase or decrease the sound volume level.

R button

Press the R button to return to previous menu screen.

RECALL button

Press the "RECALL" button to display the current system status.

- ① Input label
- ② Aspect mode (see page 20)
During 3D images (see page 35)
Audio input (see page 58)
Profile name (see page 32)
NANODRIFT Saver operating (see page 39)
- ③ Off timer
The off timer indicator is displayed only when the off timer has been set.
- ④ Clock display (see page 55)

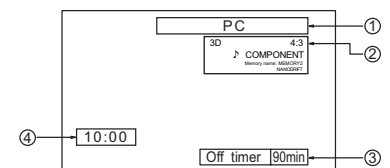

Digital Zoom

(see page 21)

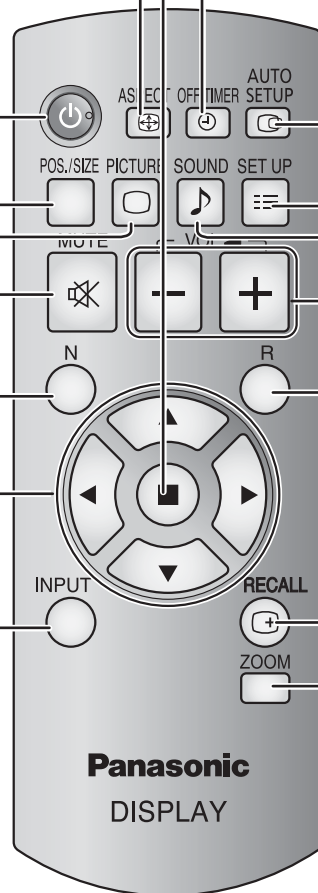

ASPECT Controls

The Plasma Display will allow you to enjoy viewing the picture at its maximum size, including wide screen cinema format picture.

Note:

Be aware that if you put the display in a public place for commercial purposes or a public showing and then use the aspect mode select function to shrink or expand the picture, you may be violating the copyright under copyright law. It is prohibited to show or alter the copyrighted materials of other people for commercial purposes without the prior permission of the copyright holder.



Press repeatedly to move through the aspect options:
For details about the aspect mode, please see "List of Aspect Modes" (page 66).
For VIDEO (S VIDEO) signal input:

→ 4:3 → Zoom1 → Zoom2 → Zoom3 → 16:9 → 14:9 → Just

[from the unit]

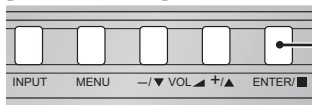

The aspect mode changes each time the ENTER button is pressed.

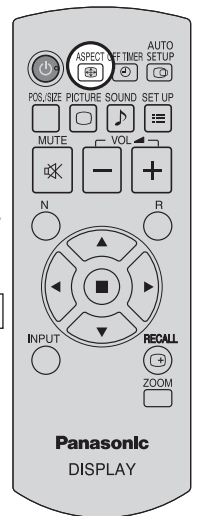

For PC signal input:

→ 4:3 → Zoom → 16:9

For SD signal input (525 (480) / 60i • 60p, 625 (575) / 50i • 50p):

→ 4:3 → Zoom1 → Zoom2 → Zoom3 → 16:9 → 14:9 → Just

For HD signal input [1125 (1080) / 60i • 50i • 60p • 50p • 24p • 25p • 30p • 24sF, 1250 (1080) / 50i, 750 (720) / 60p • 50p]:

→ 4:3 → 4:3 Full → Zoom1 → Zoom2 → Just ← 14:9 ← 16:9 ← Zoom3 ←

Notes:

- The aspect mode is memorized separately for each input terminal.
- Do not allow the picture to be displayed in 4:3 mode for an extended period, as this can cause a permanent image retention to remain on the Plasma Display Panel.

All Aspect mode

Set "All Aspect" to "On" in Options menu to enable the extended aspect mode (page 55). When All Aspect mode, the aspect mode of pictures is switched as follows. For details about the aspect mode, please see "List of Aspect Modes". (page 66)

For VIDEO (S VIDEO) signal input:

→ 4:3 → Zoom1 → Zoom2 → Zoom3 → 16:9 → 14:9 → Just

For PC signal input:

→ 4:3 → Zoom → 16:9

For SD signal input (525 (480) / 60i • 60p, 625 (575) / 50i • 50p):

→ 4:3 → Zoom1 → Zoom2 → Zoom3 → 16:9 → 14:9 → Just

For HD signal input [1125 (1080) / 60i • 50i • 60p • 50p • 24p • 25p • 30p • 24sF, 1250 (1080) / 50i, 750 (720) / 60p • 50p]:

→ 4:3 Full → Zoom1 → Zoom2 → Zoom3 → 16:9 → 14:9 → Just1 → Just2 → 4:3 (1) → 4:3 (2)

Digital Zoom

This displays an enlargement of the designated part of the displayed image.

1 Display the operation guide.

ZOOM
 Press to access Digital Zoom.
 The operation guide will be displayed.

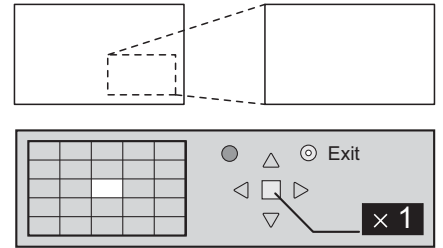

During Digital Zoom, only the following buttons can be operated.

[Remote control]

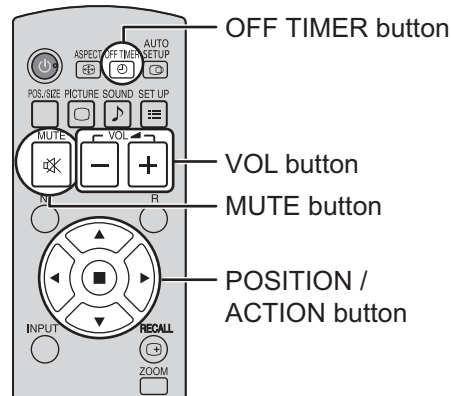

[Unit]

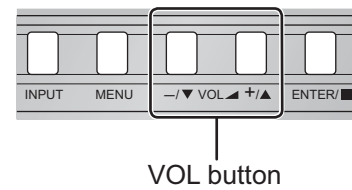

2 Select the area of the image to be enlarged.

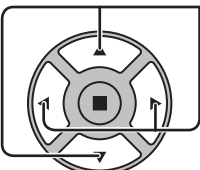
 Press on the enlargement location to select.
 The cursor will move.

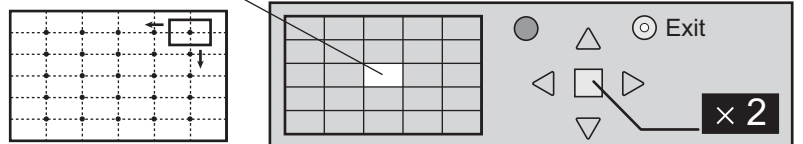

3 Select the magnification required for the enlarged display.

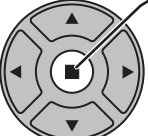
 Each time this is pressed, the magnification factor changes.
 This is shown in the image being displayed.

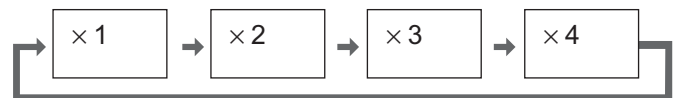

4 Return to normal display (quit Digital Zoom).

R
 Press to exit from the Digital Zoom.

Notes:

- When power goes OFF (including "Off Timer" operation), Digital Zoom terminates.
- The Digital Zoom function cannot be selected while in the following operation state:
 When MULTI DISPLAY Setup is On (see page 44).
 When Portrait Setup is On (see page 46).
 When Screensaver (except for Negative image) is running (see page 36)
- While Digital Zoom is in operation, "Adjusting Pos./Size" cannot be used.

Viewing 3D images

You can enjoy viewing 3D images with contents or programmes compatible with 3D effect by using the 3D eyewear (optional).

Note:

You need the 3D IR TRANSMITTER (optional) and the 3D eyewear (optional) to view the 3D images on this display. For further information, see the instruction manuals of the 3D IR TRANSMITTER and the 3D eyewear.

This display supports “Frame Sequential”^{*1}, “Side by Side”^{*2}, “Top and Bottom”^{*3} and “Simultaneous”^{*4} 3D formats.

*1: The 3D format that the images for the left and right eyes are recorded with the high definition quality and alternately played back

*2, *3: See “Table of images that can be seen for each 3D Picture Format and the source image format” on page 23.

*4: To view “Simultaneous” 3D images, one of the following terminal boards should be installed:

Dual HD-SDI Terminal Board for 3D (TY-FB30DHD3D), Dual DVI-D Terminal Board for 3D (TY-FB30DD3D)

To view the 3D images

To view the contents of the Frame Sequential format (ex. 3D-compatible Blu-ray Disc, etc.) with 3D effect

Connect the 3D-compatible player via an HDMI cable (see page 10) and playback the contents.

- Use fully wired HDMI compliant cable.
- For the settings of the player, read the manual of the player.
- If you use the non 3D-compatible player, the images will be displayed without 3D effect.

To view the contents of 3D formats other than Frame Sequential with 3D effect.

Match the picture format in “3D Picture Format” (see page 35) before viewing.

- You can view “Side by Side” and “Top and Bottom” with 3D effect even if you use the non 3D-compatible player.
- Please consult the suppliers of contents or programmes for availability of this service.

① **Turn the 3D Eyewear on**

- See the instruction manual of 3D eyewear for handling.

② **Put on the 3D Eyewear**

③ **Watch the 3D images**

Notes:













- If the room is lit by fluorescent lights and light appears to flicker when using the 3D Eyewear, switch off the fluorescent light. Alternatively, please set “3D Refresh Rate” to “100Hz” or “120Hz” whichever reduces flicker. (see page 50)
- 3D content will not be correctly visible if the 3D Eyewear is worn upside down or back-to-front.
- Do not wear the 3D Eyewear when watching anything other than 3D images. Liquid crystal displays (such as computer screens, digital clocks or calculators, etc.) may be difficult to see while wearing the 3D Eyewear.
- Do not use the 3D Eyewear as sunglasses.
- 3D effects may be perceived differently depending on the person.

Troubleshooting for 3D Eyewear

| Symptoms | Checks |
|--|--|
| Cannot see 3D images | <ul style="list-style-type: none"> • Has the 3D Eyewear been switched On? • Ensure that “3D Picture Display” in “3D Settings” is set to “3D”. (see page 35) • Some 3D image signals may not be automatically recognized as 3D images. Set “3D Picture Format” in “3D Settings” to match the picture format. (see page 35) • Check that there are no obstacles between the 3D IR TRANSMITTER and the 3D Eyewear. If the 3D Eyewear stops receiving the infrared signal for about 5 minutes, the 3D Eyewear will be turned off automatically. • Check the available area to use the 3D Eyewear. • Depending on the person, the 3D images may be difficult to see, or cannot be seen, especially in users that have a different level of eyesight between the left and right eyes. Take the necessary steps (wearing glasses etc.) to correct your eyesight before use. |
| 3D Eyewear is turned off automatically | <ul style="list-style-type: none"> • Check that there are no obstacles between the 3D IR TRANSMITTER and the 3D Eyewear or that the 3D Eyewear is placed inside the coverage area. If the 3D Eyewear stops receiving the infrared signal for about 5 minutes, the 3D Eyewear will be turned off automatically. |
| There is something wrong with the 3D images | <ul style="list-style-type: none"> • Switch “Reverse” and “Normal” under “3D Picture Sequence” in “3D Settings” (see page 35). |
| Indicator lamp will not light when the 3D glasses are turned ON. | <ul style="list-style-type: none"> • The battery may be running low or flat. Change the battery or charge the 3D glasses. |

Table of images that can be seen for each 3D Picture Format and the source image format

If the picture appears to be abnormal, refer to the table below to choose the correct 3D picture format setting.

| 3D Picture Format \ Source image format | Auto | Side by Side | Top and Bottom | Native |
|---|---|---|---|---|
| Side by side |  *1 |  Normal*2 |  |  |
| Top and bottom |  *1 |  |  Normal*2 |  |
| Normal format (2D) |  Normal |  |  |  Normal |

*1 When the source image is not recognized correctly

*2 When “3D Picture Display” is set to “3D”, the images will be displayed with 3D effect. When set to “2D”, displayed without 3D effect.

• Depending on the player or contents, the image may be different from the above illustrations.

On-Screen Menu Displays

Remote Control

Unit

1 Display the menu screen.

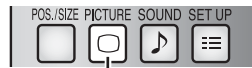

Press to select.
(Example: Picture menu)



Press several times.

MENU

Each time the MENU button is pressed, the menu screen will switch.

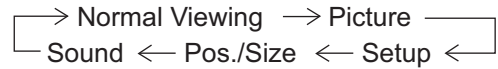

2 Select the item.

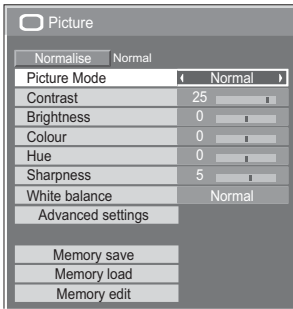

(Example: Picture menu)

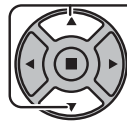

Select.

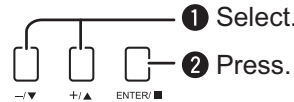

3 Set.



Set.

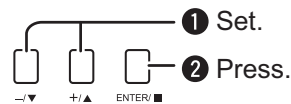

4 Exit the menu.



Press.
Press \bigcirc to return to the previous menu.



Press several times.

MENU

Menu display list

Note: Menu that cannot be adjusted is grayout. Adjustable menu changes depending on signal, input and menu setting.

Picture menu

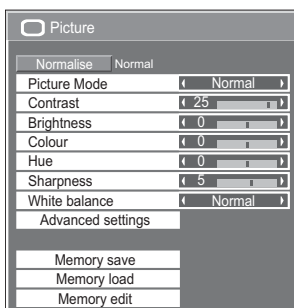

see page 28-32

Setup menu

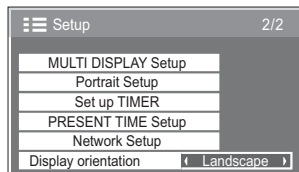
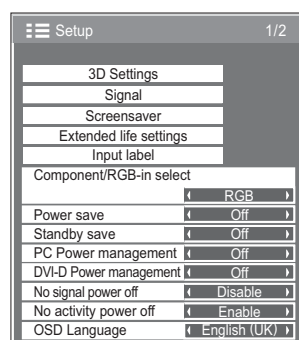

see page 34-52

Pos./Size menu

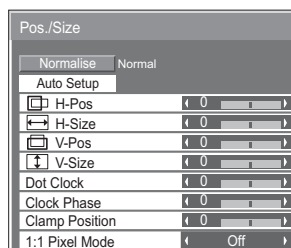

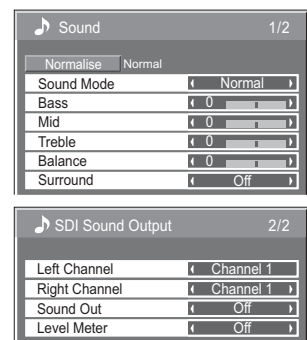

see page 25-27

Sound menu

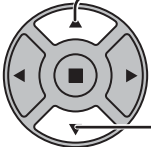
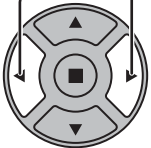

see page 33

Adjusting Pos./Size

- 1  Press to display the Pos./Size menu.
- 2  Press to select the menu to adjust.
- 3  Press to adjust the menu.
- 4  Press to exit from adjust mode.

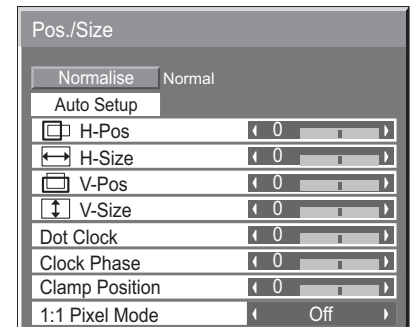

Note:

Unadjustable items are grayed out.
Adjustable items differ depending on the input signal and the display mode.

Notes:

- Adjustment details are memorized separately for different input signal formats (Adjustments for component signals are memorized for 525 (480) / 60i · 60p, 625 (575) / 50i · 50p, 1125 (1080) / 60i · 50i · 60p · 50p · 24p · 25p · 30p · 24sF, 1250 (1080) / 50i, 750 (720) / 60p · 50p each, and RGB/PC/Digital signals are memorized for each frequency.)
- If a “Cue” or “Rew” signal from a VCR or DVD player is received, the picture position will shift up or down. This picture position movement cannot be controlled by the Picture Pos./Size function.

Auto Setup When inputting a PC signal as an example, “H-Pos/V-Pos”, “H-Size/V-Size”, “Dot Clock” and “Clock Phase” are automatically corrected.

This setting is enabled under the following conditions:

- This setting is not activated during Multiple display, Portrait display or Digital Zoom.
- When inputting an analog signal (Component/PC):
This setting is enabled if “Component/RGB-in select” (see page 48) in Setup menu is “RGB”.
- When inputting a digital signal (HDMI/DVI):
A PC format signal enables this setting.

When the signal is not PC format, this setting is enabled only if “Over Scan” (see page 26) is “Off” or “1:1 Pixel Mode” (see page 27) is “On”. “H-Size/V-Size” is not automatically adjusted.

This setting will be invalid and will not work under the following conditions:

- When VIDEO signal input
- Aspect is set to “Just”
- “Display size” in the Options menu (see page 54) is set to “On”

Using Remote Control

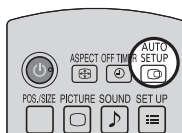

When  on the remote control is pressed, “Auto Setup” will be executed.

When Auto Setup does not work, “Invalid” is displayed.

Auto mode

When the “Auto Setup” is set to “Auto” in the Options menu (see page 55), automatic position adjustment starts:

- When the display power is turned ON.
- When the input signal is switched.

Adjusting Pos./Size

Notes:

- If the dot clock frequency of an analog signal is 162 MHz or higher, “Dot Clock” and “Clock Phase” cannot be automatically corrected.
- When digital signal input, Dot Clock and Clock Phase cannot be made.
- Auto Setup may not work when a cropped or dark image is input. In such case, switch to a bright image with borders and other objects are clearly shown, and then try auto setup again.
- Depending on the signal, out of alignment may occur after Auto Setup. Carry out fine tuning for the position/size as required.
- If Auto Setup cannot set properly for vertical frequency 60Hz XGA signal (1024×768@60Hz, 1280×768@60Hz, and 1366×768@60Hz), pre-selecting the individual signal in “XGA Mode” (see page 49) may results in correct Auto Setup.
- Auto Setup does not work well when a signal such as additional information is superimposed out of valid image period or intervals between synchronizing and image signals are short, or for image signal with tri-level synchronizing signal added.
- If Auto Setup cannot adjust correctly, select “Normalise” once and press ACTION (■), then adjust Pos./Size manually.

H-Pos

Adjust the horizontal position.

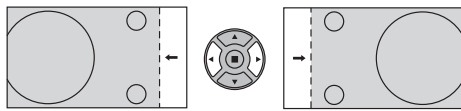

V-Pos

Adjust the vertical position.

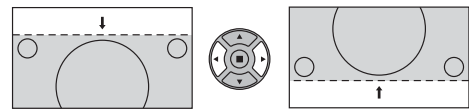

H-Size

Adjust the horizontal size.

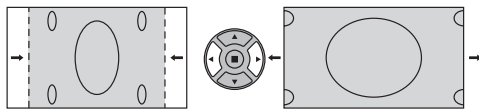

V-Size

Adjust the vertical size.

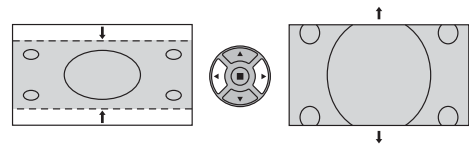

Dot Clock (During Component/PC input signal)

Periodic striped pattern interference (noise) may occur when a striped pattern is displayed. If this happens, adjust so that any such noise is minimized.

Clock Phase (During Component/PC input signal)

Eliminate the flickering and distortion.

Over scan Turn image over scan On/Off.

Configurable signals are as follows:

525i, 525p, 625i, 625p, 750/60p, 750/50p (Component Video, RGB, DVI, SDI, HDMI)

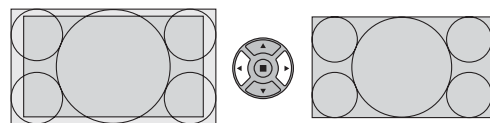

On

Off

Notes:

- When “Off” is set, “H-Size” and “V-Size” cannot be adjusted.
- When the “Display size” is set to “On” in the Options menu, this setting will be invalid. (see page 54)

Clamp Position (During Component/PC input signal)

Adjusts the clamp position when black parts of the image have no detail due to underexposure or are tinged with green.

Optimum value for Clamp Position adjustment

When black parts have no detail due to underexposure (blackout)

→ Value that causes least blackout is the optimum.

When black parts are tinged with green

→ Value that cancels the greenishness without causing blackout is the optimum.

1:1 Pixel Mode Adjusts the display size when 1125i, 1125p or 1250i signal is input.

Notes:

- Select On when you would like to replay 1920 × 1080 input signal.
- Applicable input signal;
1125 (1080) / 50i · 60i · 24sF · 24p · 25p · 30p · 50p · 60p, 1250 (1080) / 50i
- Select Off when flickering is shown around the image.
- H-Size and V-Size cannot be adjusted when On is selected.

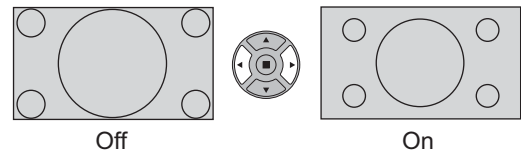

1:1 Pixel Mode (2k1k) When the input signal is a 2k1k signal (2048 × 1080 / 24p, 2048 × 1080 / 24sF), the display size is adjusted as follows. (For 2k1k signals)

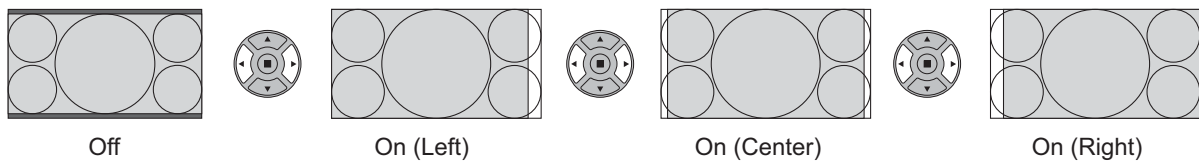

Note:

2k1k signals can only be received when the Dual Link HD-SDI Terminal Board (TY-FB11DHD) or the Dual HD-SDI Terminal Board for 3D (TY-FB30DHD3D) is installed.

Helpful Hint (/ **Normalise** Normalisation)

While the Pos./Size display is active, if either the N button on the remote control is pressed at any time or the ACTION () button is pressed during "Normalise", then all adjustment values are returned to the factory settings.

Picture Adjustments

1  Press to display the Picture menu.

2 Select to adjust each item.

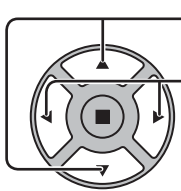
 Press to select the menu to adjust.
 Select the desired level by looking at the picture behind the menu.

Note:
 Menu that cannot be adjusted is grayout. Adjustable menu changes depending on signal, input and menu setting.

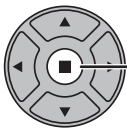
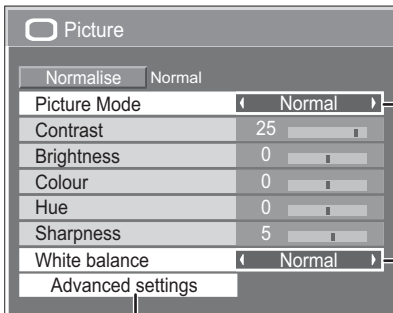

Press to enter Advanced settings.

Advanced settings
 Enables fine picture adjustment at a professional level (see next page).

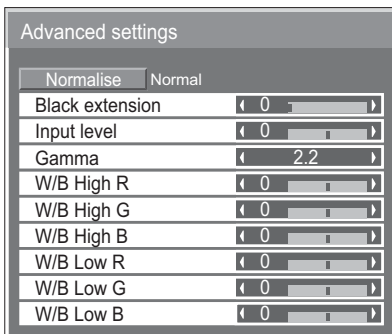

Press “◀” or “▶” button to switch between modes.

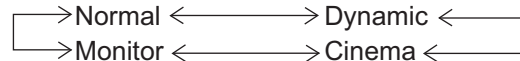

Normal

For viewing in standard (evening lighting) environments. This menu selects the normal levels of Brightness and Contrast.

Dynamic

For viewing in brighter environments. This menu selects higher than normal levels of Brightness and Contrast.

Cinema

Ideal for movies.

Monitor

For use when creating broadcast or movie content. With this picture, even if the overall average picture level (APL) changes, the brightness of areas with the same signal level does not change.

Notes:

- When “Monitor” is selected in Picture Mode, the following menu items cannot be set.
 Picture menu: Contrast
 Extended life settings: Peak limit (see page 39)
 Setup menu: Power save (see page 41)
 MULTI DISPLAY Setup menu: AI-synchronization (see page 45)
 Portrait Setup menu: AI-synchronization (see page 47)
- If you would like to change the picture and colour of the selected Picture menu to something else, adjust using the items in the Picture menu. (see next page)

Press “◀” or “▶” button to switch between modes.



Helpful Hint (/ Normalisation)

While the “Picture” menu is displayed, if either the N button on the remote control is pressed at any time or the ACTION () button is pressed during “Normalise”, then all adjustment values are returned to the factory settings.

| Item | Effect | Adjustments |
|-------------------|------------------------|--|
| Contrast | Less More | Selects the proper brightness and density for the room. |
| Brightness | Darker Brighter | Adjusts for easier viewing of dark pictures such as night scenes and black hair. |
| Colour | Less More | Adjusts colour saturation. |
| Hue | Reddish Greenish | Adjusts for nice skin colour. |
| Sharpness | Less More | Adjusts picture sharpness. |

Notes:

- You can change the level of each function (Contrast, Brightness, Colour, Hue, Sharpness) for each Picture Mode.
- The setting details for Normal, Dynamic, Cinema and Monitor respectively are memorized separately for each input terminal.
- In Contrast, there is not a noticeable change even when contrast is increased with a bright picture or reduced with a dark picture.

Advanced settings

| Item | Effect | Details |
|------------------------|-----------------|---|
| Black extension | Less More | Adjusts the dark shades of the image in gradation. |
| Input level | Less More | Adjustment of parts which are extremely bright and hard to see. |
| Gamma | Down Up | S Curve ←→ 2.0 ←→ 2.2 ←→ 2.6 |
| W/B High R | Less More | Adjusts the white balance for light red areas. |
| W/B High G | Less More | Adjusts the white balance for light green areas. |
| W/B High B | Less More | Adjusts the white balance for light blue areas. |
| W/B Low R | Less More | Adjusts the white balance for dark red areas. |
| W/B Low G | Less More | Adjusts the white balance for dark green areas. |
| W/B Low B | Less More | Adjusts the white balance for dark blue areas. |

Notes:

- Carry out “W/B” adjustment as follows.
 1. Adjust the white balance of the bright sections using the “W/B High R”, “W/B High G” and “W/B High B” settings.
 2. Adjust the white balance of the dark sections using the “W/B Low R”, “W/B Low G” and “W/B Low B” settings.
 3. Repeat steps 1 and 2 to adjust.
 Steps 1 and 2 affect each other’s settings, so repeat each step in turn to make the adjustment.
- The adjustment values are memorized separately for each input terminal.
- The adjustment range values should be used as an adjustment reference.

Helpful Hint (/ **Normalise** Normalisation)

On the remote control unit, while the “Advanced settings” menu is displayed, if either the N button is pressed at any time or the ACTION () button is pressed during “Normalise”, then all adjustment values are returned to the factory settings.

Picture Profiles

Up to 8 combinations of picture adjustment values (in the Picture menu and Advanced settings) can be stored in the display memory as profiles and applied as needed, for a convenient way to enjoy your preferred picture settings.

Picture

| | |
|-------------------|---------|
| Normalise | Normal |
| Picture Mode | Dynamic |
| Contrast | 18 |
| Brightness | 0 |
| Colour | 0 |
| Hue | 0 |
| Sharpness | 3 |
| White balance | Normal |
| Advanced settings | |

Memory save → **Save profiles**(page 31)
 Memory load → **Load profiles**(page 32)
 Memory edit → **Edit profiles**(page 32)



Picture

| | |
|-------------------|--------|
| Normalise | Normal |
| Picture Mode | Normal |
| Contrast | 25 |
| Brightness | 0 |
| Colour | 0 |
| Hue | 0 |
| Sharpness | 5 |
| White balance | Normal |
| Advanced settings | |

Save profiles ↓ Save the picture adjustment values in the MEMORY1 profile

Edit the profile ← Delete or rename the profile

| |
|-------------------|
| MY PICTURE |
| MEMORY2 |
| MEMORY3 |
| MEMORY4 |
| ... |
| MEMORY8 |

| |
|----------------|
| MEMORY1 |
| MEMORY2 |
| MEMORY3 |
| MEMORY4 |
| ... |
| MEMORY8 |

Load the profile ↓ Apply the MEMORY1 profile

Original picture



Picture

| | |
|-------------------|--------|
| Normalise | Normal |
| Picture Mode | Normal |
| Contrast | 0 |
| Brightness | 0 |
| Colour | 0 |
| Hue | 0 |
| Sharpness | 0 |
| White balance | Normal |
| Advanced settings | |

Custom picture



Picture

| | |
|-------------------|--------|
| Normalise | Normal |
| Picture Mode | Normal |
| Contrast | 25 |
| Brightness | 0 |
| Colour | 0 |
| Hue | 0 |
| Sharpness | 5 |
| White balance | Normal |
| Advanced settings | |

Saving profiles

Follow these steps to save picture adjustment values as profiles.

Note:

When the settings are locked in “Extended life settings”, profiles cannot be saved.

1 Specify the picture quality in the Picture menu and Advanced settings. (see page 29, 30)

2 In the Picture menu, select “Memory save”.



3 Select a profile name for saving the picture adjustment values.

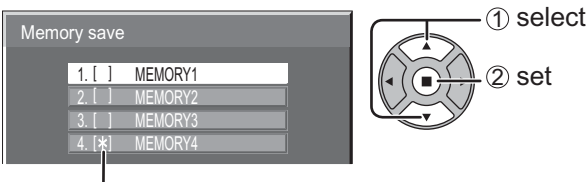

“*” appears for a profile in which the picture adjustments have already been saved.

4 Select “Ok”.

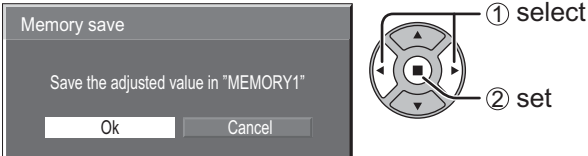

5 Enter a name for the profile.

[Entering profile names]

Profile names can be up to 40 characters.

To enter text, select characters in the on-screen keyboard.

Edit the default profile name in the text box as desired.

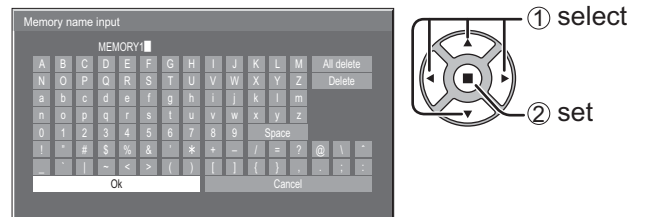

Example: Specifying “MY PICTURE”

① Select “All delete”.



All text is deleted.

To delete individual characters, select “Delete”.

② Select “M”.



Repeat this process to enter the next character.

③ Select “Y”.



④ Select “Space”.



6 When you finished entering the profile name, select “Ok”.

To cancel saving the profile, select “Cancel”.

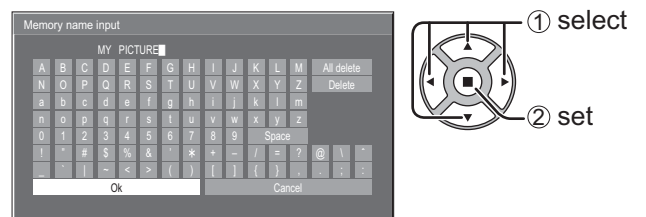

Loading profiles

Load profiles and apply the picture adjustment values to the display as follows.

Notes:

- Loaded profiles are stored in memory according to the selected input terminal. (see page 17)
- When the settings are locked in “Extended life settings”, profiles cannot be loaded.

1 In the Picture menu, select “Memory load”.

2 Select the profile to load.

When profile is being loaded, profile name is displayed.

Editing profiles

Delete or rename profiles as follows.

<Deleting profiles>

1 In the Picture menu, select “Memory edit”.

2 Select “Memory delete”.

3 Select the profile to delete.
To delete all profiles, select “All delete”.

4 Select “Ok”.

<Renaming profiles>

1 In the Picture menu, select “Memory edit”.

2 Select “Memory name change”.

3 Select the profile to rename.

4 Enter a name for the profile.
Entering profile names → page 31

5 When you finished entering the profile name, select “Ok”.
To cancel renaming the profile, select “Cancel”.

Sound Adjustment

1  Press to display the Sound menu.

2 Select to adjust each item.

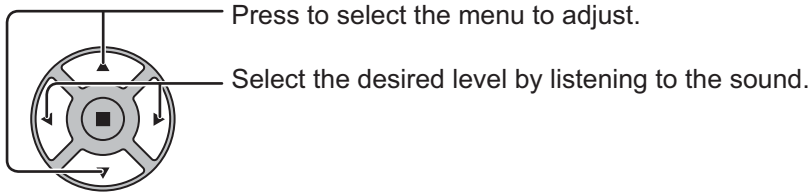

3  Press to exit from adjust mode.

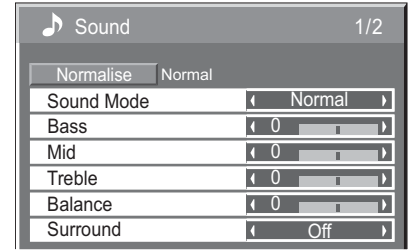

| Item | Details |
|-------------------|---|
| Sound Mode | Normal: Emits the original sound. Dynamic: Accentuates sharp sound. Clear: Attenuates human voice. |
| Bass | Adjusts low pitch sounds. |
| Mid | Adjusts normal sounds. |
| Treble | Adjusts high pitch sounds. |
| Balance | Adjusts left and right volumes. |
| Surround | Select On or Off. |

Note: Bass, Mid, Treble and Surround settings are memorized separately for each Sound Mode.

Helpful Hint (/ **Normalise** Normalisation)

While the "Sound" menu is displayed, if either the N button on the remote control is pressed at any time or the ACTION (■) button is pressed during "Normalise", then all adjustment values are returned to the factory settings.

SDI Sound Output

This menu is available only when selecting a slot that any of the following terminal boards is installed: HD-SDI Terminal Board with audio (TY-FB10HD), Dual Link HD-SDI Terminal Board (TY-FB11DHD), or Dual HD-SDI Terminal Board for 3D (TY-FB30DHD3D)

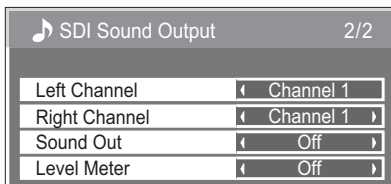



| Item | Details |
|----------------------|---|
| Left Channel | Channel 1 to Channel 16 Selects left audio channel. |
| Right Channel | Channel 1 to Channel 16 Selects right audio channel. |
| Sound Out | On ↔ Off On: Enables audio output. Off: Disables audio output. |
| Level Meter | Off ↔ 1-8ch ↔ 9-16ch Sets audio channels to show in the audio level meter. 8 channels are displayed in the audio level meter; 4 channels each on both right and left sides of the display. Off: Hides the audio level meter. 1-8ch: Displays the audio level meter (1-8ch) 9-16ch: Displays the audio level meter (9-16ch) |

PRESENT TIME Setup / Set up TIMER

The timer can switch the Plasma Display On or Off.

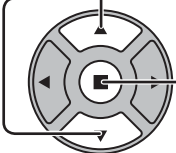

Before attempting Timer Set, confirm the PRESENT TIME and adjust if necessary.
Then set POWER ON Time / POWER OFF Time.

1  Press to display the Setup menu.

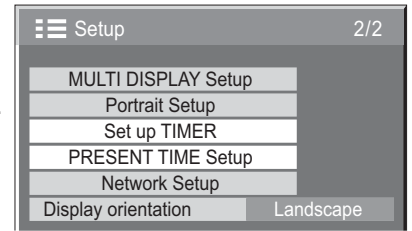
2  Press to select Set up TIMER or PRESENT TIME Setup.
 Press to display the Set up TIMER screen or PRESENT TIME Setup screen.



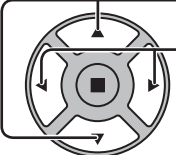

PRESENT TIME Setup

1  Press to select DAY or PRESENT TIME.
 Press to setup DAY or PRESENT TIME.
▶ button: Forward
◀ button: Back

Notes:

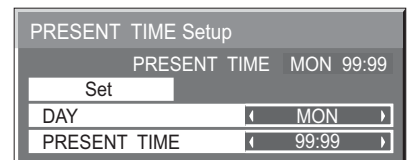
- Pressing “◀” or “▶” button once changes PRESENT TIME 1 minute.
- Pressing “◀” or “▶” button continuously changes PRESENT TIME by 15 minutes.

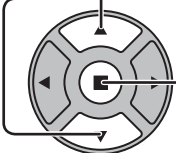



2  Press to select Set.
 Press to store PRESENT TIME Setup.

Notes:

- Set cannot be selected unless PRESENT TIME is set.
- Unless setting the present time other than “99:99”, “DAY” and “PRESENT TIME” cannot be set.
- The settings of “DAY” and “PRESENT TIME” are reset when leaving the display turned off for about 7 days for the following reasons:
Pressing ⏻/| switch of the unit to turn off the display.
Disconnecting the AC cord.
Interruption of power supply.

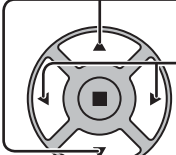

Set up TIMER

1  Press to select POWER ON Time / POWER OFF Time.
 Press to setup POWER ON Time / POWER OFF Time.
▶ button: Forward
◀ button: Back

Notes:

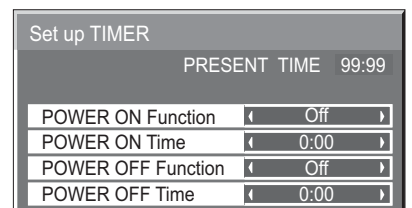
- Pressing “◀” or “▶” button once changes POWER ON Time / POWER OFF Time 1 minute.
- Pressing “◀” or “▶” button continuously changes POWER ON Time / POWER OFF Time by 15 minutes.

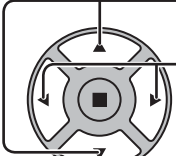

2  Press to select POWER ON Function/POWER OFF Function.
 Press to select On.

Note: Timer function will not work unless “PRESENT TIME” is set.

3D Settings

To view the 3D images, please adjust and setup the 3D settings.

Note:

Set these settings for each input terminals.

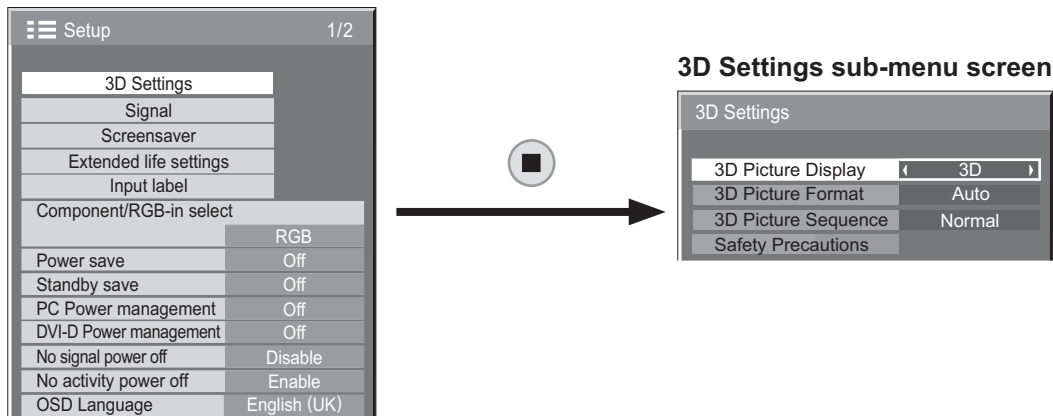

• 3D Picture Display

3D ↔ 2D

3D: Use of 3D Eyewear. You can see 3D images for 3D image signal and 2D images for 2D image signal.

2D: No use of 3D Eyewear. You can see 2D images instead of 3D images.

When set to "3D", "3D" is displayed during 3D images.

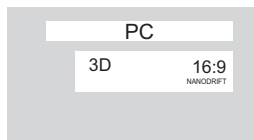

• 3D Picture Format

3D images method is set.

Auto: 3D images are automatically displayed according to the signal.

Simultaneous: Set this format when selecting a slot that one of the following terminal boards is installed:
Dual HD-SDI Terminal Board for 3D (TY-FB30DHD3D), Dual DVI-D Terminal Board for 3D (TY-FB30DD3D)

Side by Side/Top and Bottom: One of the formats of the 3D standard. Select these formats as necessary.

Native: Displays the input signal as it is. Use to identify the format type of the input signal.

• 3D Picture Sequence

Reverse ↔ Normal

This function calibrates the timing to switch the right and left images as well as the timing to switch the shutter of right and left 3D Eyewear.

Select "Reverse" if you feel that the sense of depth is unusual.

• Safety Precautions



Displays the precautions for viewing 3D images.

Screensaver (For preventing image retention)

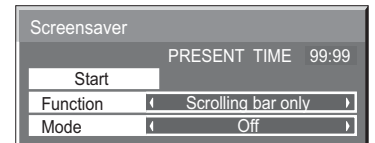
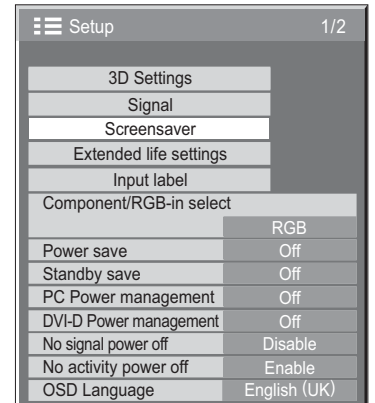
Do not display a still picture, especially in 4:3 mode, for any length of time. If the display must remain on, a Screensaver should be used.

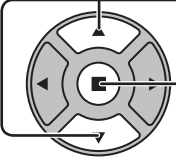

1  Press to display the Setup menu.

2  Press to select Screensaver.
 Press to display Screensaver screen.

3 Function selection

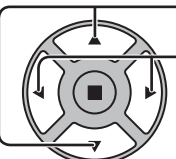
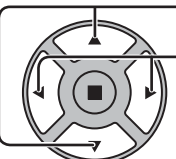
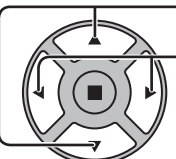
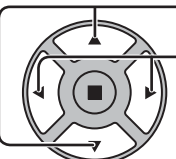
 Press to select Function.
 Press to select the desired function.
 Negative image ↔ Scrolling bar only ←
 White screen ↔ Overlay scrolling bar ←

Negative image : Negative image will be displayed on the screen.

Scrolling bar only : A white bar will scroll from left to right. The image won't be displayed.

Overlay scrolling bar : The brightness of the image will be decreased and a white bar will scroll on it.

White screen : The whole screen will be white.

4 Mode selection

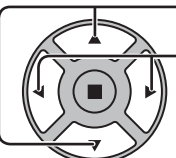
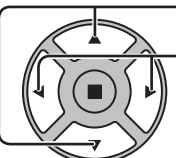
 Press to select Mode.
 Press to select each mode items.

Off
 ↓
 Interval : Operates when Periodic Time and Operating Time are setup and those times arrive.
 ↓
 Time Designation : Operates when Start Time and Finish Time are setup and those times arrive.
 ↓
 Standby after SCR Saver: Operates while Screensaver duration, and display enters standby mode.
 ↓
 On : Operates when Start is selected and the ACTION (■) button is pressed.

5 Start setting

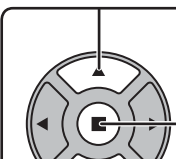
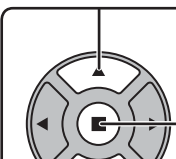
 When the Mode is set to On, press to select Start.
 Press to start Screensaver.
 The menu screen will disappear and the Screensaver will be activated. **To stop the Screensaver under On, press the R button or any buttons on the main unit.**

Note: When the display is turned off, the Screensaver will be deactivated.

Setup of Screensaver Time

After selecting Time Designation, Interval or Standby after SCR Saver, the relevant Time Setup will become available for selection and the Operating Time may be set. (Time cannot be set when "Mode" is "On" or "Off".)

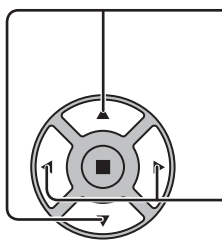

- Press to select Start Time / Finish Time (when Time Designation is selected).
- Press to select Periodic Time / Operating Time (when Interval is selected).
- Press to select Screensaver duration (when Standby after SCR Saver is selected).
- Press to setup.
- ▶ button: Forward
- ◀ button: Back

| Screensaver | |
|-------------|--------------------|
| | PRESENT TIME 15:00 |
| Start | |
| Function | Scrolling bar only |
| Mode | Time Designation |
| Start Time | ◀ 6:15 ▶ |
| Finish Time | ◀ 12:30 ▶ |

| Screensaver | |
|----------------|--------------------|
| | PRESENT TIME 15:00 |
| Start | |
| Function | Scrolling bar only |
| Mode | Interval |
| Periodic Time | ◀ 12:00 ▶ |
| Operating Time | ◀ 3:00 ▶ |

| Screensaver | |
|----------------------|-------------------------|
| | PRESENT TIME 15:00 |
| Start | |
| Function | Scrolling bar only |
| Mode | Standby after SCR Saver |
| Screensaver duration | ◀ 6:15 ▶ |

Notes:

- Pressing "◀" or "▶" button once changes the Time 1 minute.
[However, switching occurs every 15 minutes when Periodic Time is selected.]
- Pressing "◀" or "▶" button continuously changes the Time by 15 minutes.
- "Screensaver duration" of the "Standby after SCR Saver" can be set from 0:00 to 23:59. When this is set to "0:00", "Standby after SCR Saver" will not be activated.

Note: Timer function will not work unless "PRESENT TIME" is set.

Reduces screen image retention

Extended life settings

The following settings are setup to reduce image retention:

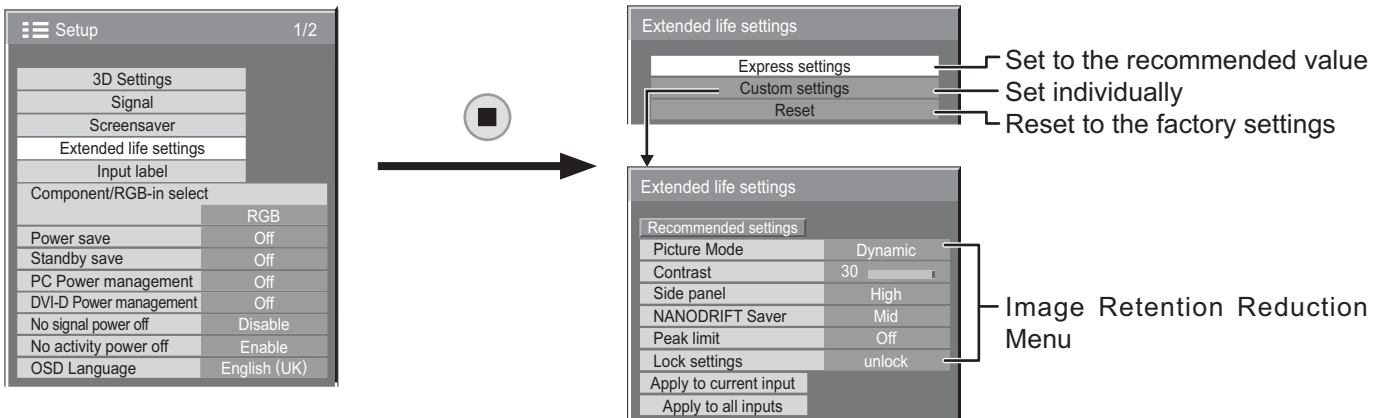

Image Retention Reduction Menu

“Extended life settings” enables you to set the following 5 menus (Image Retention Reduction Menu) as recommended values or set them individually.

Picture Mode

Contrast

“Picture Mode” and “Contrast” are same as “Picture” menu items (see page 28). The settings of this menu will be reflected to the “Picture” menu.

Side panel

Do not display a picture in 4:3 mode for an extended period, as this can cause an image retention to remain on the side panels on either side of the display field.

To reduce the risk of such an image retention, illuminate the side panels.

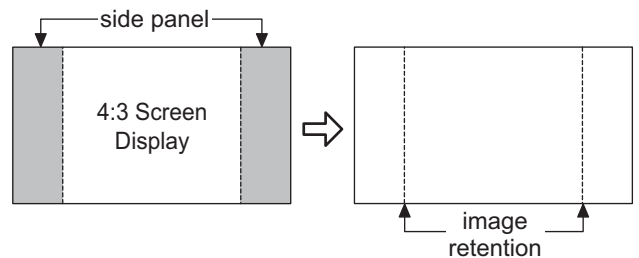

This function may be applicable to the non-picture area.

- Off:** Darken both ends.
- Low:** Make it dark gray.
- Mid:** Make it gray.
- High:** Make it light gray.

Notes:

- To reduce the occurrence of image retention, set the Side panel to High.
- The side panel may flash (alternate black/white) depending on the picture being shown on the screen. Using Cinema mode will reduce such flashing.

NANODRIFT Saver

Moves the display position of the screen slightly to reduce image retention on the display panel.

Low–High: NANODRIFT Saver operates. The display position of the screen moves at set time intervals. You can set the screen movement range. Some of the screen may appear to be missing as a result of this operation. If you change the value, a mask is displayed in the range where the picture is missing as a result of position movement.



When “NANODRIFT” Image Retention Reduction is operating, “NANODRIFT” is displayed.

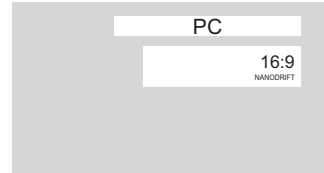

Note:

This function does not work in the following cases.

- When “MULTI DISPLAY Setup” is set to “On”
- When “PORTRAIT Setup” is set to “On”
- When in digital zoom mode

Peak limit

On: Suppresses image contrast (peak brightness).

Note: When a still picture is viewed for an extended time, the screen may become slightly darker. (see page 65)

Express settings

Set the “Image Retention Reduction” menu to the recommended settings.

All menus will be locked.

- Picture Mode: Normal
- Contrast: Recommended setting for each model
- Side panel: High
- NANODRIFT Saver: Mid
- Peak limit: On

1 Select “Express settings”.

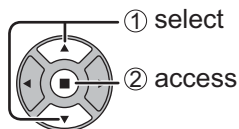
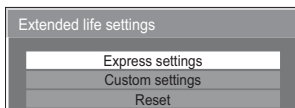

2 Select the input to apply the settings.

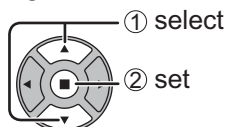
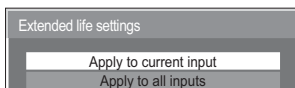

3 Select “Yes”.

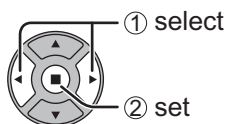
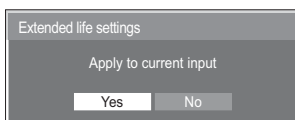

Reduces screen image retention

Custom settings

Set the individual "Image Retention Reduction" menu.

1 Select "Custom settings".

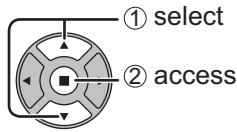
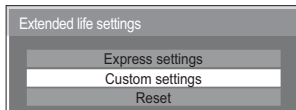

2 To set each menu to the recommended setting: Select "Recommended settings".

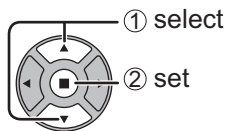
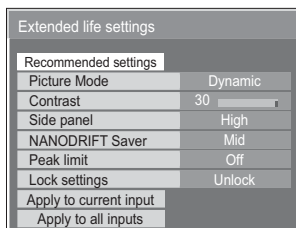

Each menu will be set as same as the "Express settings".

3 Set each menu.

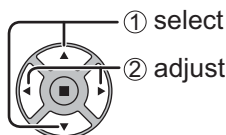
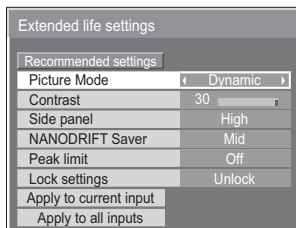

4 To lock each menu setting: Set the "Lock settings" to "Lock".

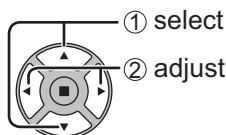
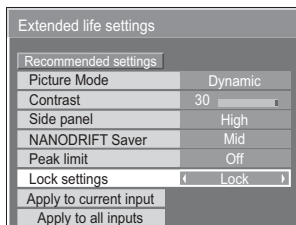

When a menu is locked, it is grayed out and cannot be set.

"Picture Mode" and "Contrast" will no longer be able to set in the "Picture" menu, and they are labeled with icon to indicate their locked status. Also, "Normalise", "Memory save" and "Memory load" are not available.

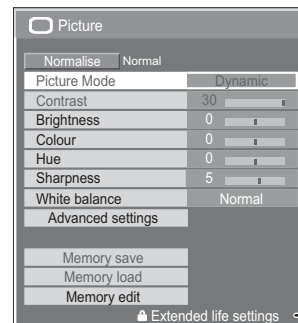

5 Select the input to apply the settings.

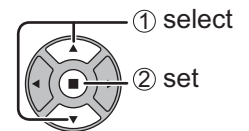
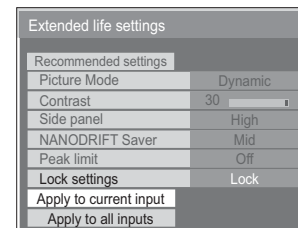

6 Select "Yes".

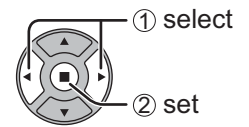
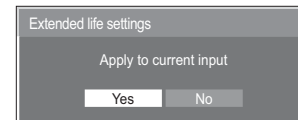

Reset

Reset the "Image Retention Reduction" menu to the factory settings. Each menu will be unlocked.

1 Select "Reset".

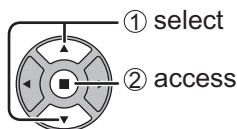
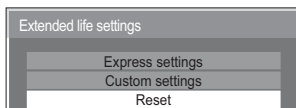

3 Select "Yes".

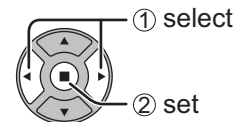
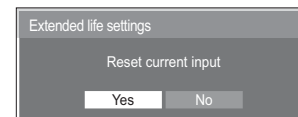

2 Select the input to reset the settings.

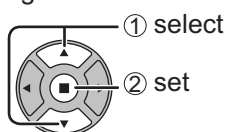
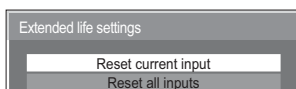

Reduces power consumption

- **Power save:** When this function is turned On, luminous level of the Plasma Display is suppressed, so power consumption is reduced.
- **Standby save:** When this function is turned On, power consumption of the microcomputer is reduced during power supply standby (see page 15, 17, 18), so standby power of the set is reduced.
- **PC Power management:** When this function is set to On, it operates under the following conditions to turn the power on or off automatically.
When no pictures (HD/VD sync signals) are detected for 30 or so seconds during PC signal input:
→ Power is turned off (standby); the power indicator lights up orange.
When pictures (HD/VD sync signals) are subsequently detected:
→ Power is turned on; the power indicator lights up green.
- **DVI-D Power management:** When this function is set to On, it operates under the following conditions to turn the power on or off automatically.
When no pictures (sync signal) are detected for 30 or so seconds during DVI signal input:
→ Power is turned off (standby); the power indicator lights up orange.
When pictures (sync signal) are subsequently detected:
→ Power is turned on; the power indicator lights up green.
- **No signal power off:** Equipment power supply is turned Off when there is no signal.
When this is set to "Enable", the power supply of the unit goes Off 10 minutes after the input signals stop.
- **No activity power off:** When this function is set to "Enable", the power is turned off (standby) automatically when there is no operation of the Plasma Display for 4 hours.
Starting from 3 minutes before the turn off, the remaining time will be displayed.

Notes:

- This function operates only during PC signal input.
- This function is effective when "Sync" is set to "Auto", "Component / RGB-in select" is set to "RGB" and during normal viewing.
- This function operates only during DVI signal input.
- This function is invalid during input from DVI-D Terminal Board (TY-FB11DD) and Dual DVI-D Terminal Board for 3D (TY-FB30DD3D).
- Depending on the type of terminal board equipped, this function may be invalid.

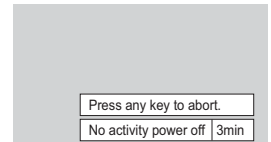

When the power is turned off due to this function, a message "Last turn off due to 'No activity power off'." is displayed next time the power is turned on.

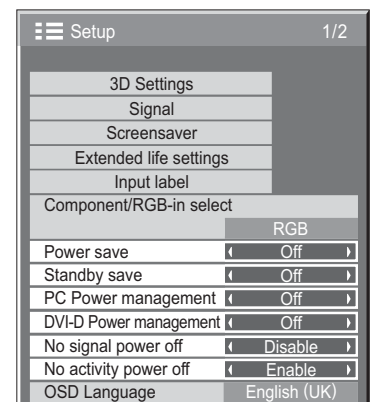
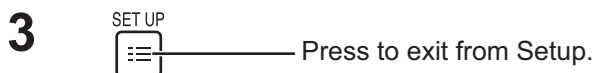
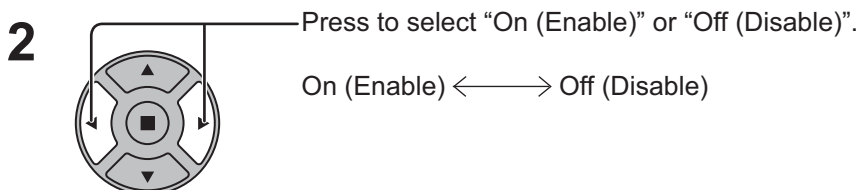
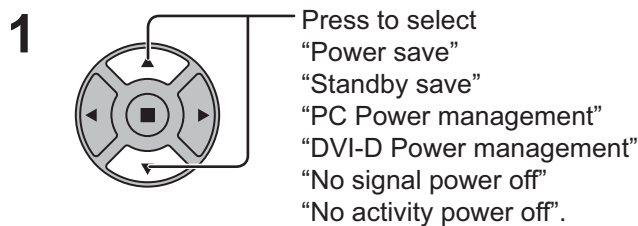

Note:

During the screensaver is running, this function is disabled.

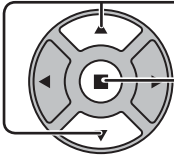
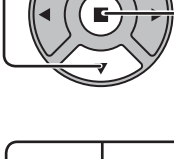
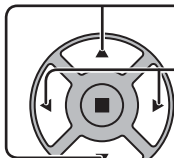

Customizing the Input labels

This function can change the label of the Input signal to be displayed. (see page 17)

- 1  Press to display the Setup menu.
- 2  Press to select Input label.
 Press to display the Input label screen.
- 3  Press to select image input.
 Press to change input label.

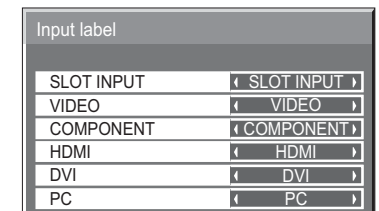
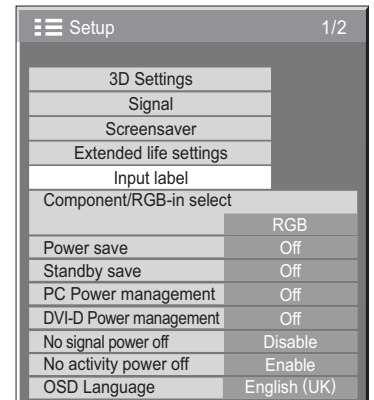

| | |
|-------------------------------|---|
| Image input [SLOT INPUT]*1 | Input label SLOT INPUT / DVD1 / DVD2 / DVD3 / DVD4 / Blu-ray1 / Blu-ray2 / Blu-ray3 / Blu-ray4 / CATV / VCR / STB / (Skip) |
| [VIDEO] | VIDEO / DVD1 / DVD2 / DVD3 / DVD4 / Blu-ray1 / Blu-ray2 / Blu-ray3 / Blu-ray4 / CATV / VCR / STB / (Skip) |
| [COMPONENT]*2 | COMPONENT / DVD1 / DVD2 / DVD3 / DVD4 / Blu-ray1 / Blu-ray2 / Blu-ray3 / Blu-ray4 / CATV / VCR / STB / (Skip) |
| [HDMI] | HDMI / DVD1 / DVD2 / DVD3 / DVD4 / Blu-ray1 / Blu-ray2 / Blu-ray3 / Blu-ray4 / CATV / VCR / STB / (Skip) |
| [DVI] | DVI / DVD1 / DVD2 / DVD3 / DVD4 / Blu-ray1 / Blu-ray2 / Blu-ray3 / Blu-ray4 / CATV / VCR / STB / (Skip) |
| [PC] | PC / DVD1 / DVD2 / DVD3 / DVD4 / Blu-ray1 / Blu-ray2 / Blu-ray3 / Blu-ray4 / CATV / VCR / STB / (Skip) |

(Skip): The INPUT button press will skip its input.

*1 "SLOT INPUT" is displayed when a Terminal Board is installed.

*2 "COMPONENT" may be displayed as "RGB" depending on the setting of "Component/RGB-in select". (see page 48)

When a Terminal Board with dual input terminals is installed

"SLOT INPUT" is displayed as "SLOT INPUT A" and "SLOT INPUT B" and independent settings are available.

| | |
|----------------|--|
| [SLOT INPUT A] | SLOT INPUT A / DVD1 / DVD2 / DVD3 / DVD4 / Blu-ray1 / Blu-ray2 / Blu-ray3 / Blu-ray4 / CATV / VCR / STB / (Skip) |
| [SLOT INPUT B] | SLOT INPUT B / DVD1 / DVD2 / DVD3 / DVD4 / Blu-ray1 / Blu-ray2 / Blu-ray3 / Blu-ray4 / CATV / VCR / STB / (Skip) |

When a Terminal Board with fixed display (such as Tuner Board) is installed

Only fixed display and (Skip) are available as Input label of "SLOT INPUT".

| | |
|--------------|------------------------|
| [SLOT INPUT] | fixed display / (Skip) |
|--------------|------------------------|

Selecting the On-Screen Menu Language

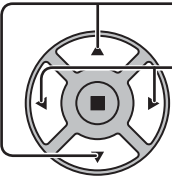
-  Press to display the Setup menu.
-  Press to select the OSD Language.
 Press to select your preferred language.

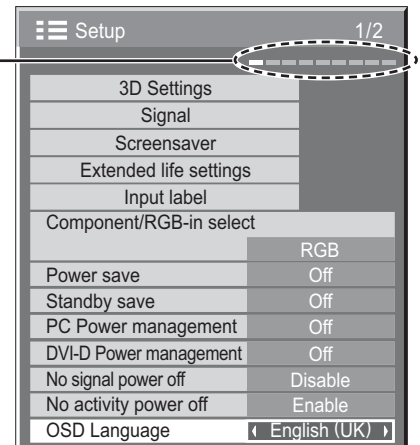

■ Selectable languages

- English(UK)
- Deutsch
- Français
- Italiano
- Español
- ENGLISH(US)
- 中文.....(Chinese)
- 日本語.....(Japanese)
- Русский.....(Russian)

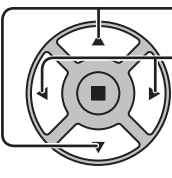

Display orientation

Sets the fan control, panel drive control, and the display style of on-screen menu for vertical installation.

-  Press to display the Setup menu.
-  Press to select Display orientation.
 Press to select "Landscape" or "Portrait".
-  Press to exit from adjust mode

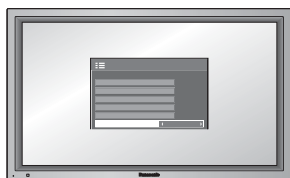
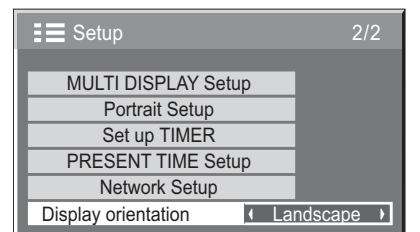

Landscape

Fan control and panel drive control for horizontal installation.



Portrait

Fan control and panel drive control for vertical installation. On-screen menu will be rotated 90 degrees counterclockwise to be suitable for the setting.

Notes:

- Turn up the power switch for the upward direction when you set Display vertically.
- When you change this setting, fan control and panel drive control will be switched as the power is turned on next time.

Setup for MULTI DISPLAY

By lining up Plasma Displays in groups, for example, as illustrated below, an enlarged picture may be displayed across all screens.

For this mode of operation, each plasma display has to be set up with a Display number to determine its location.

Note:

During Multi display, the 3D images are displayed as 2D images.

(Example)



group of 4 (2 × 2) group of 9 (3 × 3) group of 16 (4 × 4) group of 25 (5 × 5)



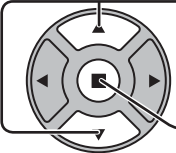
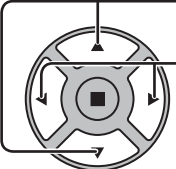

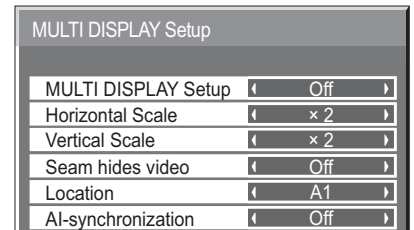
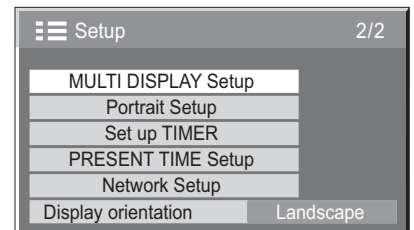
How to Setup MULTI DISPLAY

- 1  Press to display the Setup menu.
- 2  Press to select the MULTI DISPLAY Setup.
Press to display the "MULTI DISPLAY Setup" menu.
- 3  Press to select the MULTI DISPLAY Setup.
Press to select "On" or "Off".

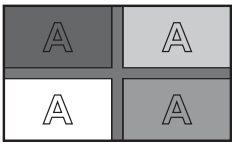
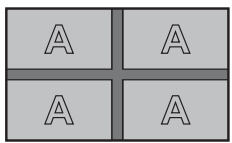

| Item | Details | | | | | | | | | | | | | | | | | | | | | | | | | | | | | | | | | | | | | | | | | | | | | | | | | | | | | | | | | |
|----------------------------|---|----|----|----|----|----|----|----|----|----|----|----|----|----|----|----|----|----|----|----|----|----|----|----|----|----|----|----|----|----|----|----|----|----|----|----|----|----|----|----|----|----|----|----|----|----|----|----|----|----|----|----|----|----|----|----|----|----|
| MULTI DISPLAY Setup | Select "On" or "Off". Note: If you set MULTI DISPLAY Setup to On, Portrait Setup will be unavailable. | | | | | | | | | | | | | | | | | | | | | | | | | | | | | | | | | | | | | | | | | | | | | | | | | | | | | | | | | |
| Horizontal Scale | Select "× 1", "× 2", "× 3", "× 4", "× 5". | | | | | | | | | | | | | | | | | | | | | | | | | | | | | | | | | | | | | | | | | | | | | | | | | | | | | | | | | |
| Vertical Scale | Select "× 1", "× 2", "× 3", "× 4", "× 5". | | | | | | | | | | | | | | | | | | | | | | | | | | | | | | | | | | | | | | | | | | | | | | | | | | | | | | | | | |
| Seam hides video | Select "On" or "Off". To hide joints between displays. To show joints between displays. <div style="display: flex; justify-content: space-around; align-items: center;"> <div style="text-align: center;">  <p>Example</p> <p>Suitable for moving image display.</p> <p>On</p> </div> <div style="text-align: center;">  <p>Example</p> <p>Suitable for still image display.</p> <p>Off</p> </div> </div> | | | | | | | | | | | | | | | | | | | | | | | | | | | | | | | | | | | | | | | | | | | | | | | | | | | | | | | | | |
| Location | Select the required arrangement number. (A1-E5 : Refer to the following) Display Number locations for each arrangement. (Examples) <div style="display: flex; justify-content: space-around; align-items: flex-start;"> <div style="text-align: center;"> <p>(2 × 1)</p> <table border="1" style="border-collapse: collapse;"> <tr><td>A1</td><td>A2</td></tr> </table> </div> <div style="text-align: center;"> <p>(2 × 3)</p> <table border="1" style="border-collapse: collapse;"> <tr><td>A1</td><td>A2</td></tr> <tr><td>B1</td><td>B2</td></tr> <tr><td>C1</td><td>C2</td></tr> </table> </div> <div style="text-align: center;"> <p>(4 × 2)</p> <table border="1" style="border-collapse: collapse;"> <tr><td>A1</td><td>A2</td><td>A3</td><td>A4</td></tr> <tr><td>B1</td><td>B2</td><td>B3</td><td>B4</td></tr> </table> </div> <div style="text-align: center;"> <p>(4 × 4)</p> <table border="1" style="border-collapse: collapse;"> <tr><td>A1</td><td>A2</td><td>A3</td><td>A4</td></tr> <tr><td>B1</td><td>B2</td><td>B3</td><td>B4</td></tr> <tr><td>C1</td><td>C2</td><td>C3</td><td>C4</td></tr> <tr><td>D1</td><td>D2</td><td>D3</td><td>D4</td></tr> </table> </div> <div style="text-align: center;"> <p>(5 × 5)</p> <table border="1" style="border-collapse: collapse;"> <tr><td>A1</td><td>A2</td><td>A3</td><td>A4</td><td>A5</td></tr> <tr><td>B1</td><td>B2</td><td>B3</td><td>B4</td><td>B5</td></tr> <tr><td>C1</td><td>C2</td><td>C3</td><td>C4</td><td>C5</td></tr> <tr><td>D1</td><td>D2</td><td>D3</td><td>D4</td><td>D5</td></tr> <tr><td>E1</td><td>E2</td><td>E3</td><td>E4</td><td>E5</td></tr> </table> </div> </div> | A1 | A2 | A1 | A2 | B1 | B2 | C1 | C2 | A1 | A2 | A3 | A4 | B1 | B2 | B3 | B4 | A1 | A2 | A3 | A4 | B1 | B2 | B3 | B4 | C1 | C2 | C3 | C4 | D1 | D2 | D3 | D4 | A1 | A2 | A3 | A4 | A5 | B1 | B2 | B3 | B4 | B5 | C1 | C2 | C3 | C4 | C5 | D1 | D2 | D3 | D4 | D5 | E1 | E2 | E3 | E4 | E5 |
| A1 | A2 | | | | | | | | | | | | | | | | | | | | | | | | | | | | | | | | | | | | | | | | | | | | | | | | | | | | | | | | | |
| A1 | A2 | | | | | | | | | | | | | | | | | | | | | | | | | | | | | | | | | | | | | | | | | | | | | | | | | | | | | | | | | |
| B1 | B2 | | | | | | | | | | | | | | | | | | | | | | | | | | | | | | | | | | | | | | | | | | | | | | | | | | | | | | | | | |
| C1 | C2 | | | | | | | | | | | | | | | | | | | | | | | | | | | | | | | | | | | | | | | | | | | | | | | | | | | | | | | | | |
| A1 | A2 | A3 | A4 | | | | | | | | | | | | | | | | | | | | | | | | | | | | | | | | | | | | | | | | | | | | | | | | | | | | | | | |
| B1 | B2 | B3 | B4 | | | | | | | | | | | | | | | | | | | | | | | | | | | | | | | | | | | | | | | | | | | | | | | | | | | | | | | |
| A1 | A2 | A3 | A4 | | | | | | | | | | | | | | | | | | | | | | | | | | | | | | | | | | | | | | | | | | | | | | | | | | | | | | | |
| B1 | B2 | B3 | B4 | | | | | | | | | | | | | | | | | | | | | | | | | | | | | | | | | | | | | | | | | | | | | | | | | | | | | | | |
| C1 | C2 | C3 | C4 | | | | | | | | | | | | | | | | | | | | | | | | | | | | | | | | | | | | | | | | | | | | | | | | | | | | | | | |
| D1 | D2 | D3 | D4 | | | | | | | | | | | | | | | | | | | | | | | | | | | | | | | | | | | | | | | | | | | | | | | | | | | | | | | |
| A1 | A2 | A3 | A4 | A5 | | | | | | | | | | | | | | | | | | | | | | | | | | | | | | | | | | | | | | | | | | | | | | | | | | | | | | |
| B1 | B2 | B3 | B4 | B5 | | | | | | | | | | | | | | | | | | | | | | | | | | | | | | | | | | | | | | | | | | | | | | | | | | | | | | |
| C1 | C2 | C3 | C4 | C5 | | | | | | | | | | | | | | | | | | | | | | | | | | | | | | | | | | | | | | | | | | | | | | | | | | | | | | |
| D1 | D2 | D3 | D4 | D5 | | | | | | | | | | | | | | | | | | | | | | | | | | | | | | | | | | | | | | | | | | | | | | | | | | | | | | |
| E1 | E2 | E3 | E4 | E5 | | | | | | | | | | | | | | | | | | | | | | | | | | | | | | | | | | | | | | | | | | | | | | | | | | | | | | |

| Item | Details |
|--------------------|---|
| AI-Synchronization | <p>Select "Off" or "On".</p> <p>The brightness depends on each display's setting.</p>  <p>Equalize the brightness of all the displays.</p>  <p>Off</p> <p>On</p> <p>Notes:</p> <ul style="list-style-type: none"> If you set AI-synchronization to On, the following menus will be unavailable and these settings will be fixed to the initial values. Picture menu: Colour, Hue, Input level (Advanced settings) This function cannot be adjusted during input from VIDEO terminal. |

4  Press to exit from Setup.









ID Remote Control Function

You can set the remote control ID when you want to use this remote control on one of several different displays.

Note:

To operate this function, please purchase ID remote controller sold separately.

Object model : EUR7636090R

- Switch  to  on the right side.
- Press the  button on the remote control.
- Press one of  - ,  for the tens digit setting.
- Press one of  - ,  for the units digit setting.

Notes:

- The numbers in 2, 3 and 4 should be set up quickly.
- Adjustable ID number range is 0 - 99.
- If a number button is pressed more than two times, the first two numbers become the ID number for the remote control.

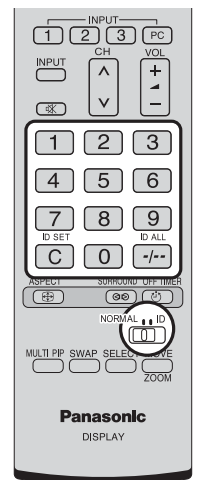

ID remote control button operation

The operation is the same as normal remote control except for the  button.

ID Cancellation

Press  button on remote control. (This has the same effect as pressing the , ,  buttons at the same time.)

Notes:

- Set the Remote ID "On" to operate the ID remote control.
If Remote ID is set to "On", you can use the remote control without identical ID number during option menu display. (see page 54)
- The ID remote control cannot be used when ID select is set to anything other than 0, and the remote control ID is not the same as the ID select number (see page 54).

Set up for Portrait

Divide an input image into 3 parts, and display one of them to a plasma display which is set vertically. The image will be enlarged 3 times and rotated 90-degree.

(Example)







Notes:

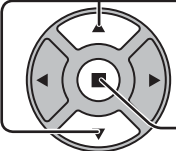

- When using the Portrait function with displays set vertically, “Display orientation” in Setup menu has to be set to “Portrait” (see page 43).
- Turn up the power switch for the upward direction when you set Display vertically.
- During Portrait display, the 3D images are displayed as 2D images.

How to setup Portrait

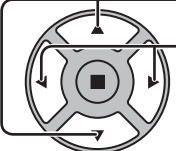

1  Press to display the Setup menu.

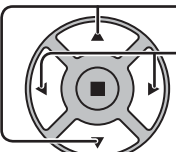
2  Press to select the Portrait Setup.
 Press to display the “Portrait Setup” menu.

3  Press to select the Portrait Setup.
 Press to select “On” or “Off”.
Note:
 If you set Portrait Setup to On, MULTI DISPLAY Setup will be unavailable.

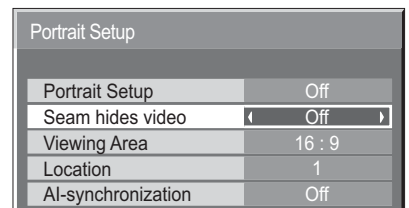
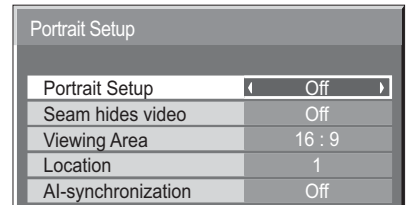
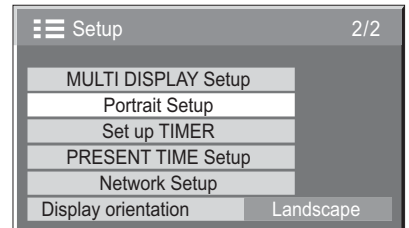
4  Press to select Seam hides video.
 Press to select “Off” , “On”.



| | |
|--|--|
| To hide joints between displays.  Suitable for moving image display. On | To show joints between displays.  Suitable for still image display. Off |
|--|--|

5 Viewing Area / Location

Viewing Area: Set a mode of image division for Portrait function.

Location: Set a location of image to be displayed for Portrait function.

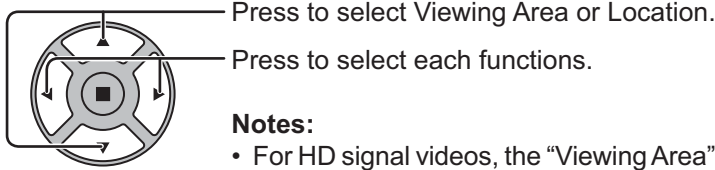

Notes:

- For HD signal videos, the “Viewing Area” is set at “16:9”, and cannot be changed.
 HD signal: 1125(1080) / 60i • 50i • 60p • 50p • 24p • 25p • 30p • 24sF, 750(720) / 60p • 50p, 1250(1080) / 50i
- When “Viewing Area” is “16:9”, the aspect mode is set to “16:9”.

| Portrait Setup | |
|--------------------|--------|
| Portrait Setup | Off |
| Seam hides video | Off |
| Viewing Area | 16 : 9 |
| Location | 1 |
| AI-synchronization | Off |

Location setting

When Portrait Setup is “On”:

Display the image of the selected location.



When Portrait Setup is “Off”:

Represent an area of the selected Location at a normal brightness and darken the rest of it.



Viewing Area and Location

The mode of image division and the Location by setting of Viewing Area is as follows.

Viewing Area : 16:9

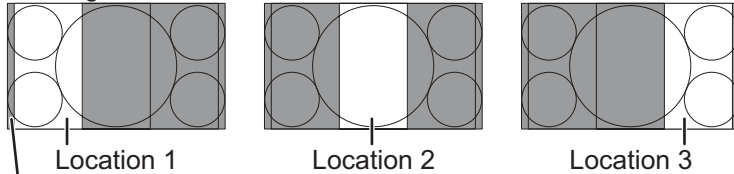

Undisplayed area (48 dots)

Viewing Area : 4:3

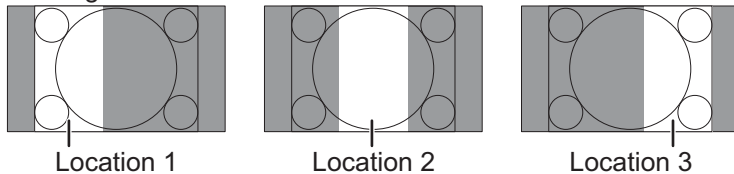

Suitable to display 16:9 images. 4:3 images extend transversely. Both right and left sides of the image are cut by 48 dots.

4:3 images are displayed without changing aspect ratio. Although the images of each Location overlap, you can adjust Pos./Size to display the image normally. (see page 25)

6 AI-synchronization

Adjust to equalize the brightness of the 3 displays when using Portrait setting.

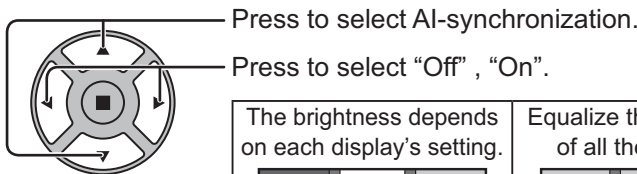

| | |
|---|---|
| <p>The brightness depends on each display's setting.</p> <p>Off</p> | <p>Equalize the brightness of all the displays.</p> <p>On</p> |
|---|---|

| Portrait Setup | |
|--------------------|--------|
| Portrait Setup | Off |
| Seam hides video | Off |
| Viewing Area | 16 : 9 |
| Location | 1 |
| AI-synchronization | Off |

Notes:

- If you set AI-synchronization to On, the following menus will be unavailable and these settings will be fixed to the initial values.
 Picture menu: Colour, Hue, Input level (Advanced settings)
- This function cannot be adjusted during input from VIDEO terminal.

7 Press to exit from adjust mode.



Setup for Input Signals

Component / RGB-in select

Select to match the signals from the source connected to the Component / RGB or PC input terminals.

Y, P_B, P_R signals ⇔ "Component"

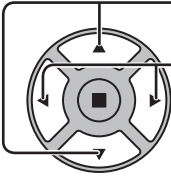
RGB signals ⇔ "RGB"

-  Press to display the Setup menu.
-  Press to select the "Component / RGB-in select".
Press to select the desired input signal.
Component ← → RGB
-  Press to exit from adjust mode.

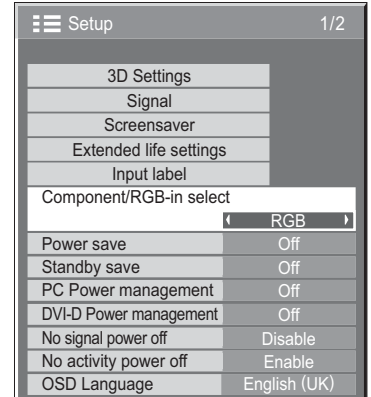

Note:



Make setting of the selected input terminal (COMPONENT/RGB IN or PC IN).

YUV / RGB-in select

Select to match the signals from the source connected to the DVI input terminals.

YUV signals ⇔ "YUV"

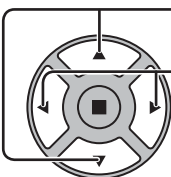
RGB signals ⇔ "RGB"

-  Press to display the Setup menu.
-  Press to select the "YUV / RGB-in select".
Press to select the desired mode.
YUV ← → RGB
-  Press to exit from adjust mode.

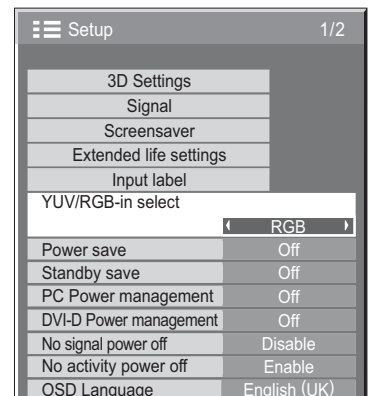

Notes:

- Selection may not be possible, depending on which optional board is installed.
- Make setting of the selected input terminal (SLOT or DVI-D IN).

Signal menu

Note:

“Signal” setup menu displays a different setting condition for each input signal.

1  Press to display the Setup menu.

2  Press to select the “Signal”.
Press to display the Signal menu.

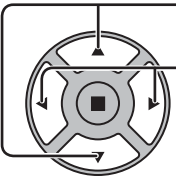
3  Press to select the menu to adjust.
Press to adjust the menu.

4  Press to exit from adjust mode.

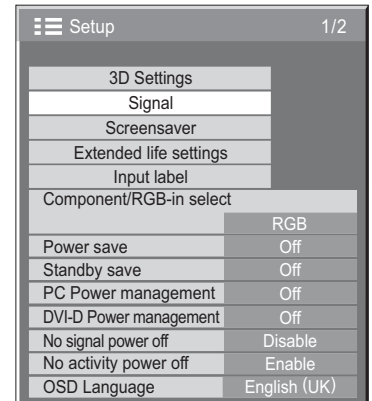

Press ACTION (■) button

For Video (S VIDEO)

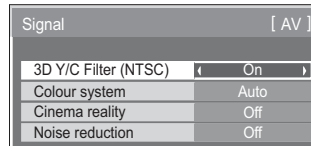

For RGB

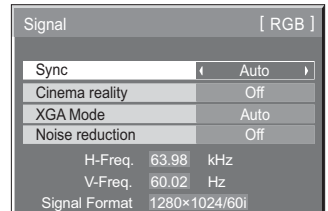

For Component

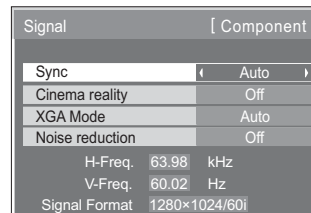

For Digital

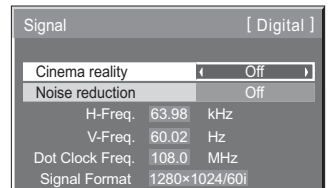

• 3D Y/C Filter (NTSC)

This menu is displayed when BNC Dual Video Terminal Board (TY-FB9BD) is installed to the unit.

Set this menu when the moving image looks unnatural during Video (S Video) input signal.

On ↔ Off

Note:

When On, this setting only affects NTSC input signals.

• Colour system

→ Auto ↔ PAL ↔ SECAM ↔ M.NTSC ↔ NTSC ←

Set the colour system to match the input signal. When “Auto” is set, Colour system will be automatically selected from NTSC/PAL/SECAM/M.NTSC.

To display PAL60 signal, select “Auto” or “PAL”.

If the picture image becomes unstable:

With the system set on Auto, under conditions of low level or noisy input signals the image may in rare cases become unstable. Should this occur, set the system to match the format of the input signal.

• Cinema reality

When “On”, the display attempts to reproduce a more natural interpretation of sources such as movie pictures, which are recorded at 24 frames per second.

If the picture is not stable, turn the setting to “Off”.

On ↔ Off

Note:

When On, this setting only affects the following signal input:

- NTSC / PAL signal input during Video (S Video) input signal.
- 525i(480i), 625i(575i), 1125(1080)/60i signal input during “Component” input signal.

• XGA Mode

This menu is displayed when the input signal is analog (Component/PC). This unit supports three types of XGA signals with 60Hz vertical frequency having different aspect ratios and sampling rates (1,024 × 768 @ 60Hz, 1,280 × 768 @ 60Hz and 1,366 × 768 @ 60Hz).

Auto ↔ 1024×768 ↔ 1280×768 ↔ 1366×768

Auto: Automatically selected from 1024×768/1280×768/1366×768.

Switch the setting to suit the input signal for better display depends on the angle of view or display resolution condition.

Note:

After making this setting, be sure to make each adjustment (such as “Auto Setup”) on the “Pos./Size” menu as necessary. (see page 25)

Setup for Input Signals

- **Sync**

This function operates only during input from PC IN terminal.

- **Setting RGB sync signal**

Confirm that the input is set to RGB input (this setting is valid only for RGB input signal).

Auto: The H and V sync or synchronized signal is automatically selected. If both input, it is selected the H and V sync.



on G: Uses a synchronized signal on the Video G signal, which is input from the G connector.



VBS: Uses a synchronized signal of Composite Sync input, which is input from the HD connector.

- **Setting Component sync signal**

Confirm that the input is set to Component input (this setting is valid only for Component input signal).

Auto: The H and V sync or synchronized signal is automatically selected. If both input, it is selected the H and V sync.



on Y: Uses a synchronized signal on the Video Y signal, which is input from the Y connector.

- **Note:**

Signals input to COMPONENT/RGB IN terminals correspond to Sync on G or Sync on Y.

- **SDI Through**

Set the active through function of the Dual Link HD-SDI Terminal Board (TY-FB11DHD).

On ↔ **Off**

On: Enables active through.

Off: Disables active through.

- **Note:**

Settings can only be performed for this menu when a slot mounted with a Dual Link HD-SDI Terminal Board (TY-FB11DHD) is selected.

- **FRAME CREATION**

Automatically compensates the picture frame rate and removes juddering movements to make the images smooth.

Off ↔ **Min*** ↔ **Mid** ↔ **Max**

* "Min" can be selected during 2D viewing.

- **Note:**

Depending on the contents, images may be noisy. To prevent the noise, change the setting.

- **3D Refresh Rate**

Reduces juddering or flicker of image due to lighting interference during 3D viewing.

100Hz ↔ **120Hz**

- **Note:**

This setting is disabled when "FRAME CREATION" is set to "Off".

- **HDMI Range**

Switches the dynamic range according to the input signal from HDMI terminal.

Video(16-235) ↔ **Full(0-255)** ↔ **Auto**

Video(16-235): If the input signal is the video range, Example: HDMI terminal output for DVD player

Full(0-255): If the input signal is full range, Example: HDMI terminal output for personal computer

Auto: Switches the dynamic range automatically between "Video(16-235)" and "Full(0-255)" according to the input signal.

- **Note:**

This function can be set only for HDMI signal input.

- **SDI Signal Format**

This menu is available only when selecting a slot that the Dual HD-SDI Terminal Board for 3D (TY-FB30DHD3D) is installed and set the input signal format for the board.

Auto ↔ YCbCr(4:2:2) 10bit ↔ YCbCr(4:2:2) 10bit 60p/50p ↔ YCbCr(4:4:4) 10bit ↔ RGB(4:4:4) 10bit

↔ YCbCr(4:2:2) 12bit ↔ YCbCr(4:4:4) 12bit ↔ RGB(4:4:4) 12bit ↔ XYZ(4:4:4) 12bit

Auto: Automatically selects the signal format according to the input signal.

• Noise reduction

Sets the following three NR (Noise Reduction) functions together.
P-NR, Mosquito NR, Block NR

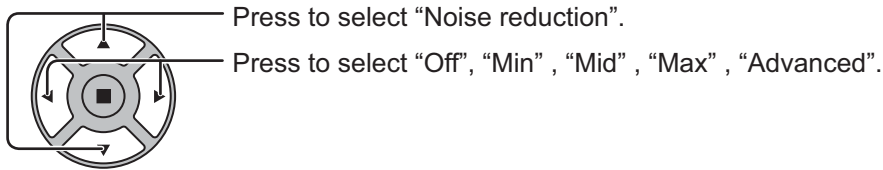

Advanced NR

Sets the three NR functions separately.

1

Press to select "Advanced".

Press to enter Advanced NR.

2

Press to select P-NR, Mosquito NR or Block NR.

Press to select "Off", "Min", "Mid", "Max".

P-NR: Automatically reduces unwanted picture noise.

Mosquito NR: Reduces mosquito noise around subtitles on MPEG videos.

Block NR: Reduces block noise when playing MPEG videos.

Note:

Noise reduction cannot be adjusted while a PC signal is being applied.

• Input signal display

Displays the frequency and the type of the current input signal.

This display is valid only for Component / RGB / PC and Digital input signal.

Display range:

Horizontal 15 - 110 kHz

Vertical 48 - 120 Hz

The dot clock frequency is displayed during DVI signal input.

| | | |
|---------------|---------------|-----|
| H-Freq. | 63.98 | kHz |
| V-Freq. | 60.02 | Hz |
| Signal Format | 1280×1024/60i | |





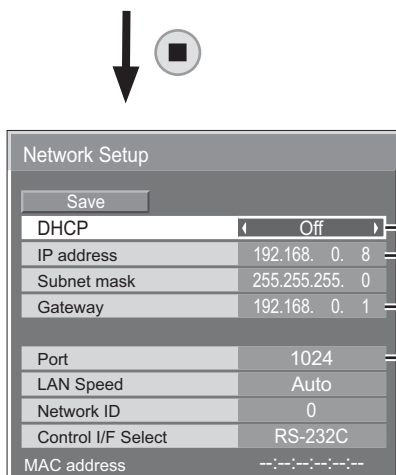
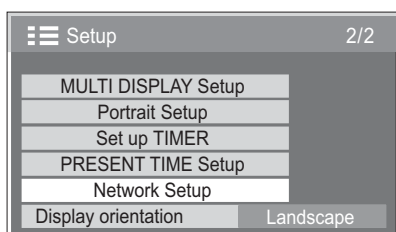

| | | |
|-----------------|---------------|-----|
| H-Freq. | 63.98 | kHz |
| V-Freq. | 60.02 | Hz |
| Dot Clock Freq. | 108.0 | MHz |
| Signal Format | 1280×1024/60i | |

Network Setup

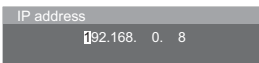





Make the various settings to use the network function.



DHCP, IP address, Subnet mask, and Gateway settings

- 1 Set DHCP.
When "Off" is selected, IP address and other settings can be set manually.
- 2 Select the item and press .
- 3 Enter an address.

 - ① Use  to select a digit.
 - ② Use  to change a number.
 - ③ Press .Pressing  will cancel the address change.
- 4 Select "Save" and press .

Port setting

- 1 Select "Port" and press .
- 2 Enter a port number.

 - ① Use  to select a digit.
 - ② Use  to change a number.
 - ③ Press .Pressing  will cancel the port number change.

Save

Save the current network Setup. Each value set for DHCP, IP address, Subnet mask, and Gateway will be saved. If "NG" is displayed, check the same IP address is not used within the same network.

DHCP (DHCP client function)

To obtain an IP address automatically using a DHCP server, set this to "On". If DHCP server is not used, set this to "Off".

IP address (IP address display and setting)

Enter an IP address if DHCP server is not used.

Subnet mask (Subnet mask display and setting)

Enter a subnet mask if DHCP server is not used.

Gateway (Gateway address display and setting)

Enter a gateway address if DHCP server is not used.

Port

Set the port number used for command control. The available setting range is 1024 – 65535. When the PLink™ protocol is used, the port setting is not necessary.

LAN Speed

Set the connection speed of the LAN environment. Select the value from Auto, 10 Half, 10 Full, 100 Half or 100 Full.

Network ID

Set the ID to identify this unit. The available setting range is 0 – 99.

Control I/F Select

Set whether to control with RS-232C (serial) or LAN. When "LAN" is set, the slot power is turned on, and power indicator is lit orange under the condition of power "Off" with remote control (stand-by state), regardless of the "Slot power" setting. (see page 55)

MAC address

Display the MAC address of this unit. However, the MAC address is not displayed when the "Control I/F Select" is set to "RS-232C".

Notes:

- To use a DHCP server, make sure the DHCP server is started.
- Contact your network administrator for details on settings.

Options Adjustments

1  Press to display the Setup menu.

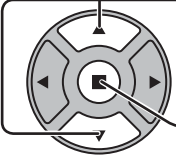
2  Press to select "OSD Language".
Press for more than 3 seconds.

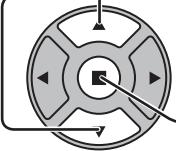
3  Press to select "Options".
Press to display the Options menu.

Options
Shipping

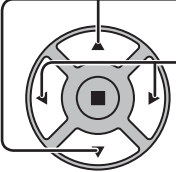

4  Press to select your preferred menu.
Press to adjust the menu.







5  Press to exit from Options menu.

| Options 1/3 | |
|----------------------|-------|
| Weekly Command Timer | |
| Audio input select | |
| Touch Panel settings | |
| Onscreen display | On |
| Initial input | Off |
| Initial VOL level | Off 0 |
| Maximum VOL level | Off 0 |
| Input lock | Off |
| Button lock | Off |
| Remocon User level | Off |

| Options 2/3 | |
|--------------------|--------|
| Off-timer function | Enable |
| Initial Power Mode | Normal |
| ID select | 0 |
| Remote ID | Off |
| Serial ID | Off |
| Display size | Off |
| Studio W/B | Off |
| Studio Gain | Off |

| Options 3/3 | |
|--|--------|
| Slot power | Off |
| Power On Screen Delay | Off |
| Clock Display | Off |
| All Aspect | Off |
| Auto Setup | Manual |
| Rotate | Off |
| Power On Message (No activity power off) | On |
| 3D Safety Precautions | On |

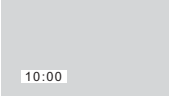
| Item | Adjustments |
|-----------------------------|--|
| Weekly Command Timer | Sets Weekly Command Timer. (see page 56) |
| Audio input select | Set up the sound when an image input is selected. (see page 58) |
| Touch Panel settings | Set while using Touch Panel (available as an option). (see page 59) |
| Onscreen display | <p>On: Displays all the following on screen.</p> <ul style="list-style-type: none"> • Power on display • Input signal switch display • No signal display • Mute and the remaining time of off-timer after  was pressed. <p>Off: Hides all the items above from view.</p> |
| Initial input | <p>Adjusts the input signal when the unit is turned on.</p> <p>Off ↔ PC ↔ SLOT INPUT*1 ↔ VIDEO ↔ COMPONENT*2 ↔ HDMI ↔ DVI</p> <p>*1 "SLOT INPUT" is displayed when an optional Terminal Board is installed.</p> <p>When a Terminal Board with dual input terminals is installed, "SLOT INPUT A" and "SLOT INPUT B" are displayed.</p> <p>*2 "COMPONENT" may be displayed as "RGB" depending on the setting of "Component/RGB-in select". (see page 48)</p> <p>Notes:</p> <ul style="list-style-type: none"> • Only the adjusted signal is displayed. (see page 17) • This menu is available only when "Input lock" is "Off". |
| Initial VOL level | <p>Press  button to adjust the volume when the unit is turned on.</p> <p>Off ↔ On</p> <p>Off: Sets normal volume.</p> <p>On: Sets your preferred volume.</p> <p>Notes:</p> <ul style="list-style-type: none"> • When "Maximum VOL level" is "On", the volume can only be adjusted between 0 and your maximum range. • You can hear the changed volume regardless of your volume setting before opening the options menu if you adjust the volume when "Initial VOL level" is "On" and cursor is on the menu. |
| Maximum VOL level | <p>Press  button to adjust the maximum volume.</p> <p>Off ↔ On</p> <p>Off: Sets auto maximum volume.</p> <p>On: Sets your preferred maximum volume.</p> <p>Notes:</p> <ul style="list-style-type: none"> • If the "Maximum VOL level" is set lower than the "Initial VOL level", the "Initial VOL level" automatically becomes the same as the "Maximum VOL level". • The volume display can go up to 63 regardless of the settings. • You can hear the changed volume regardless of your volume setting before opening the options menu if you adjust the volume when "Maximum VOL level" is "On" and cursor is on the menu. |



| Item | Adjustments |
|---|---|
| Studio W/B | <p>Off: Nullify all the settings adjusted.</p> <p>On: Sets the colour temperature for TV studio.</p> <p>Note: Valid only when the “Warm” is set as “White balance” in Picture menu.</p> |
| Studio Gain | <p>Sharpens the contrast for a better view when a part of the image is too light to see.</p> <p>Off: Disables “Studio Gain”.</p> <p>On: Enables “Studio Gain”.</p> <p>Note: This setting is valid only when the input signals are as follows: Component Video, RGB (analog), SDI, HDMI</p> |
| Slot power | <p>Off ↔ Auto ↔ On</p> <p>Off: Power is not transmitted to the slot power.</p> <p>Auto: Power is transmitted to the slot power only when main power is on.</p> <p>On: Power is transmitted to the slot power when main power is on or in the standby state.</p> <p>Note: In some cases, power is transmitted to the slot power when main power is on or in the standby state regardless of the slot power setting.</p> |
| Power On Screen Delay | <p>Off ↔ 1 ↔ 2 ↔ 3... 30</p> <p>You can set the power-on delay time of the displays to reduce the power load, when you press /I to turn on the multiple displays that are set together, for example, on MULTI DISPLAY system. Set each display's setting individually.</p> <p>Off: The display will be turned on at the same time as /I is pressed.</p> <p>1 to 30 (sec.): Set the power-on delay time (second). After pressing /I, the display will be powered on with time delay depending on this setting.</p> <p>Notes:</p> <ul style="list-style-type: none"> • During this function is working, the power indicator is blinking green. • This function also works when the power recovers from failure or after plugging off and in again the power cord. <p>After you unplug and plug the power cord in while the unit is in standby mode and also the power is being supplied to a terminal board, the unit will start supplying the power to the board with time delay according to the setting.</p> <p>The power indicator lights up red first and it turns orange when the power starts being supplied to the board.</p> |
| Clock Display | <p>Off: Not display the clock.</p> <p>On: Display the clock.</p> <p>The clock is displayed at the lower left of the screen when  button is pressed.</p> <div style="display: flex; align-items: center;">  <p>Note: When “PRESENT TIME Setup” is not set, the clock is not displayed even if “Clock Display” is “On”. (see page 34)</p> </div> |
| All Aspect | <p>Sets All Aspect mode (advanced aspect setting) or default aspect mode.</p> <p>With each press of  button, the aspect changes in the selected mode.</p> <p>Off: Default aspect mode</p> <p>On: All Aspect mode</p> <p>Aspect mode of each setting is as follows: (Example: HD signal)</p> <p>Off 4:3→4:3 Full→Zoom1→Zoom2→Zoom3→16:9→14:9→Just</p> <p>On 4:3 (1)→4:3 (2)→4:3 Full→Zoom1→Zoom2→Zoom3→16:9→14:9→Just1→Just2</p> |
| Auto Setup | <p>Sets the operational mode of the automatic position adjustment in the Pos./Size menu.</p> <p>Manual: Automatic position adjustment starts when  is pressed on the remote control or automatic position adjustment is executed from the Pos./Size menu.</p> <p>Auto: Other than remote control or menu operation, automatic position adjustment starts: When the display power is turned ON. When the input signal is switched.</p> |
| Rotate | <p>Off: Does not rotate the image.</p> <p>On: Rotates the image 180 degrees.</p> <p>Note: During the image is rotated, the 3D images are displayed as 2D images.</p> |
| Power On Message (No activity power off) | <p>Whether to show/hide No activity power off Precautions at the time of power ON is set.</p> <p>On: The warning precautions are shown at the time of power ON.</p> <p>Off: The warning precautions are not shown at the time of power ON.</p> <p>Note: This setting is enabled only if “No activity power off” is “Enable” (see page 41).</p> |

Options Adjustments

| Item | Adjustments |
|-------------------------------------|--|
| <p>3D Safety Precautions</p> | <p>3D Safety Precautions show/hide is set during power ON. On: 3D Safety Precaution is shown every time when the power is ON. Off: 3D Safety Precaution is not shown when the power is ON. When the setting changes from "On" to "Off", the confirmation screen is displayed as below. Pressing "YES" switches the setting.</p> <div data-bbox="683 376 1169 568" style="border: 1px solid black; padding: 5px; background-color: #f0f0f0; margin: 10px auto; width: fit-content;"> <p style="text-align: center; margin: 0;">3D Safety Precautions</p> <p style="text-align: center; margin: 5px 0 0 20px;">If Off is selected, the 3D safety precautions will not be displayed when power is turned on. Change Setting?</p> <p style="text-align: center; margin: 0;"> <input type="button" value="YES"/> <input type="button" value="NO"/> </p> </div> |

Normalization

When both main unit buttons and remote control are disabled due to the "Button lock", "Remocon User level" or "Remote ID" adjustments, set all the values "Off" so that all the buttons are enabled again.

Press the  button on main unit together with  button on the remote control and hold for more than 5 seconds. The "Shipping" menu is displayed and the lock is released when it disappears.

Weekly Command Timer

You can set 7-day timer programming by setting time and command.

Note:

Before setting Weekly Command Timer, set PRESENT TIME Setup. (see page 34)

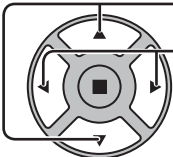
1  Press to select Function.
 Press to select "On".

Note:

- When Function is set to On, Set up TIMER (see page 34) is unavailable and Interval / Time Designation in Mode of Screensaver (see page 35) cannot be selected.

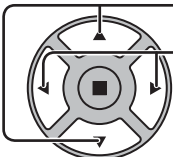
2  Press to select a day.
 Press to select a program number.

Note:

- You can set the program from 1 to 7. --- indicates unset.

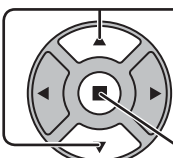
3  Press to select Program Edit.
 Press to show the Program Edit screen.

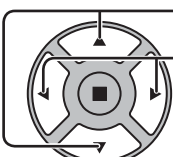
4  Press to select Program.
 Press to change the program numbers (1-7).

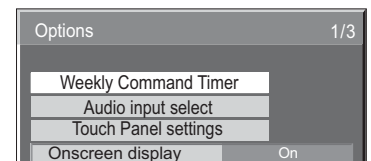

Press ACTION (■) button

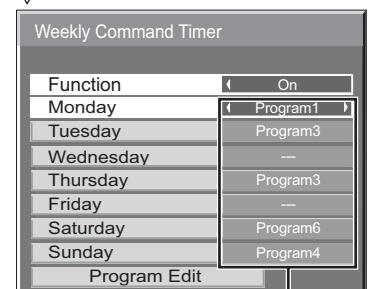

Program number

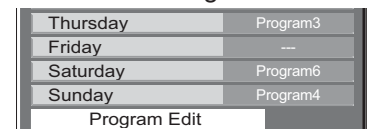

Program Edit screen

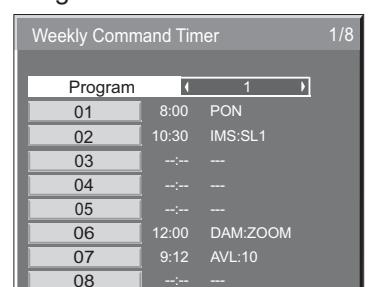

- 5**
-
- Press to select a command number.
 - Press to show the previous / next command pages (1-8) of the selected program.
 - Press to show the command setting screen.

| Command | Time | Command |
|---------|-------|----------|
| 01 | 8:00 | PON |
| 02 | 10:30 | IMS:SL1 |
| 03 | --:-- | -- |
| 04 | --:-- | -- |
| 05 | --:-- | -- |
| 06 | 12:00 | DAM:ZOOM |
| 07 | 9:12 | AVL:10 |
| 08 | --:-- | -- |

Command (--- indicates unset)
Set time of timer(--:-- indicates unset)
Command numbers

| | | |
|----|-------|----------|
| 57 | 20:00 | AVL:00 |
| 58 | 20:30 | DAM:NORM |
| 59 | 22:00 | POF |
| 60 | --:-- | -- |
| 61 | --:-- | -- |
| 62 | --:-- | -- |
| 63 | --:-- | -- |
| 64 | --:-- | -- |

- 6**
-
- Press to select Command No.
 - Press to select a command number.

Command setting screen

| Weekly Command Timer | |
|----------------------|---------|
| Program 1 | |
| Command No | 02 |
| Time | 10:30 |
| Command | IMS:SL1 |

- 7**
-
- Press to select Time / Command.
 - Press to set each item.
- Time: Set the time to execute a command program.
Pressing “◀” or “▶” button once changes “Time” 1 minute.
Pressing “◀” or “▶” button continuously changes “Time” by 15 minutes.

| Weekly Command Timer | |
|----------------------|---------|
| Program 1 | |
| Command No | 02 |
| Time | 10:30 |
| Command | IMS:SL1 |

Command: Select a command to execute at the set time. This unit has 64 commands to set. (see page 69)

- Notes:**
- Command is performed in order of execution time, regardless of the command number.
 - If a command execution time overlaps with that of other commands, these commands are performed in number order.
 - Pressing \bigcirc_N , Time becomes --:-- and Command becomes ---.

Note:
Press \bigcirc_R to return to the previous screen.

Audio input select

Set up the sound when an image input is selected.

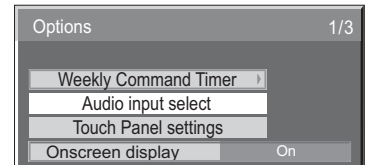

↓ Press ACTION (■) button

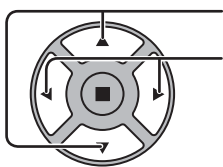
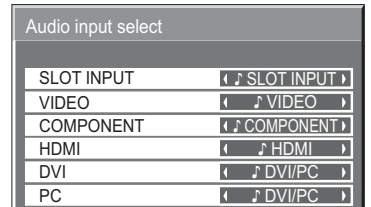

Press to select image input.

Press to select audio input.

| Image input | Audio input |
|----------------|---|
| [SLOT INPUT]*1 | SLOT INPUT / VIDEO / COMPONENT / DVI/PC / NO AUDIO |
| [VIDEO] | SLOT INPUT / VIDEO / COMPONENT / DVI/PC / NO AUDIO |
| [COMPONENT]*2 | SLOT INPUT / VIDEO / COMPONENT / DVI/PC / NO AUDIO |
| [HDMI] | SLOT INPUT / VIDEO / COMPONENT / HDMI / DVI/PC / NO AUDIO |
| [DVI] | SLOT INPUT / VIDEO / COMPONENT / DVI/PC / NO AUDIO |
| [PC] | SLOT INPUT / VIDEO / COMPONENT / DVI/PC / NO AUDIO |

DVI/PC: Sound input for both DVI and PC.

NO AUDIO: No audio input (Mute)

*1 "SLOT INPUT" is displayed when a Terminal Board is installed.

*2 "COMPONENT" may be displayed as "RGB" depending on the setting of "Component/RGB-in select".
(see page 48)

When a Terminal Board with dual input terminals is installed

"SLOT INPUT" is displayed as "SLOT INPUT A" and "SLOT INPUT B" and independent settings are available. To set other image inputs, you can select "SLOT INPUT A" and "SLOT INPUT B".

| Image input | Audio input |
|----------------|--|
| [SLOT INPUT A] | SLOT INPUT A / VIDEO / COMPONENT / DVI/PC / NO AUDIO |
| [SLOT INPUT B] | SLOT INPUT B / VIDEO / COMPONENT / DVI/PC / NO AUDIO |
| [VIDEO] | SLOT INPUT A / SLOT INPUT B / VIDEO / COMPONENT / DVI/PC / NO AUDIO |
| [COMPONENT] | SLOT INPUT A / SLOT INPUT B / VIDEO / COMPONENT / DVI/PC / NO AUDIO |
| [HDMI] | SLOT INPUT A / SLOT INPUT B / VIDEO / COMPONENT / HDMI / DVI/PC / NO AUDIO |
| [DVI] | SLOT INPUT A / SLOT INPUT B / VIDEO / COMPONENT / DVI/PC / NO AUDIO |
| [PC] | SLOT INPUT A / SLOT INPUT B / VIDEO / COMPONENT / DVI/PC / NO AUDIO |

When Image input and Audio input differ from each other, the Audio input is displayed as below.

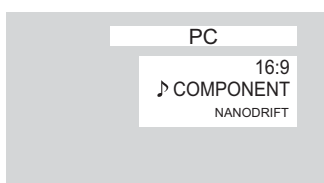

Notes:

- HDMI Audio is selectable only for HDMI Input.
- You cannot set audio of B for SLOT INPUT A, or audio of A for SLOT INPUT B.

Touch Panel settings (Settings when using Touch Panel)

The mode to restrict NANODRIFT Saver (see page 39) operation when using Touch Panel (available as an option) is set up.

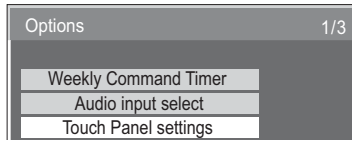

↓ Press ACTION (■) button

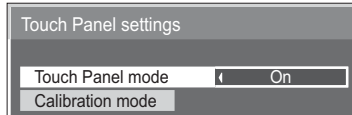

Set "Touch Panel mode" to "On".

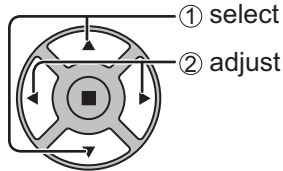

NANODRIFT Saver in Touch Panel mode: On

The value set for NANODRIFT turns into "On" and displayed in gray.

The moving distance of NANODRIFT is limited to 5 × 5 dots to prevent pointer drift on a touch panel.

Calibration mode

This setting is used in calibrating a touch panel.

You can configure the setting if "Touch Panel mode" is "On".

Select "Calibration mode" and then press .

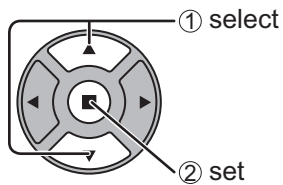
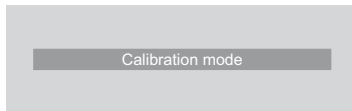
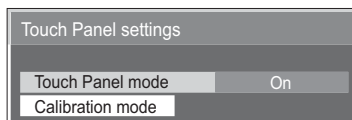

When the menu is not displayed (normal screen)

Hold down  for over 3 seconds.

The screen is displayed in the middle and NANODRIFT is deactivated for 180 seconds.

After 180 seconds or when you have the menu displayed with a remote control, Calibration mode is cancelled.

Note:

For information on how to set up Calibration, please see Touch Panel instruction manual.

Using Network Function

This unit has a network function to control the network connected display with your computer.

Note:

To use the network function, set each "Network Setup" setting and make sure to set the "Control I/F Select" to "LAN". (see page 52)

When "LAN" is set, the slot power is turned on, and power indicator is lit orange under the condition of power "Off" with remote control (stand-by state), regardless of the "Slot power" setting. (see page 55)

Example of Network Connection

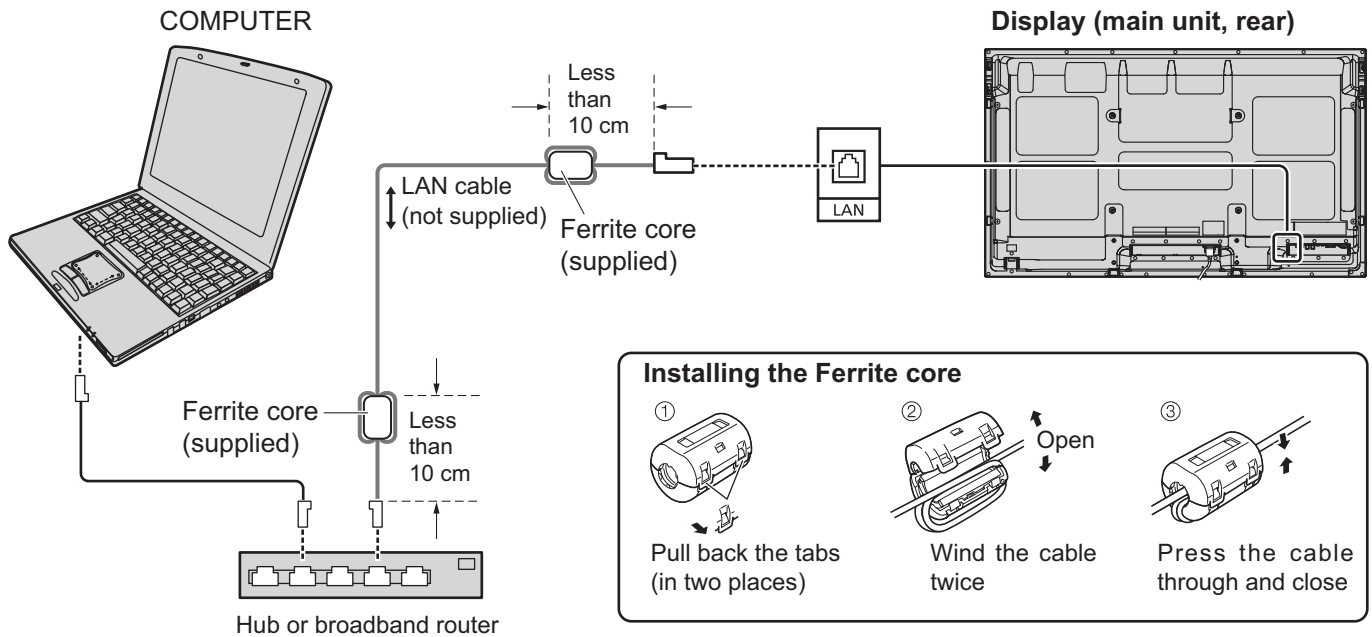

Notes:

- Make sure the broadband router or hub supports 10BASE-T/100BASE-TX.
- To connect a device using 100BASE-TX, use "category 5" LAN cable.
- Touching the LAN terminal with a statically charged hand (body) may cause damage due to its discharge. Do not touch the LAN terminal or a metal part of the LAN cable.
- For instructions on how to connect, consult your network administrator.

Command Control

Network function of the unit can control the unit in the same way as serial control from a network.

Supported commands

Commands used in the serial control are supported. (see page 14)

Note:

Consult your local Panasonic dealer for detail instructions on command usage.

PJLink™ Protocol

The network function of the unit conforms with PJLink™ class 1 and you can operate the following actions from your computer using PJLink™ protocol.

- Display setup
- Display status query

Supported commands

Commands to control the unit with PJLink™ protocol are shown in the table below.

| Command | Control | Remark |
|---------|-------------------------|---|
| POWR | Power control | Parameter 0 = Standby 1 = Power "On" |
| POWR? | Power status query | Parameter 0 = Standby 1 = Power "On" |
| INPT | Input switch | Parameter See the parameter for command INST? |
| INPT? | Input switch query | |
| AVMT | Shutter control | Parameter 10 = Picture On (picture mute deactivated), 11 = Picture Off (picture on mute) 20 = Audio On (audio mute deactivated), 21 = Audio Off (audio on mute) 30 = Shutter mode Off (picture and audio mute deactivated) 31 = Shutter mode On (picture and audio on mute) |
| AVMT? | Shutter control query | Parameter 11 = Picture Off (picture on mute) 21 = Audio Off (audio on mute) 30 = Shutter mode Off (picture and audio mute deactivated) 31 = Shutter mode On (picture and audio on mute) |
| ERST? | Error status query | Parameter First byte: Means fan error. 0 or 2. Second byte: 0 Third byte: 0 Fourth byte: 0 Fifth byte: 0 Sixth byte: Means other error. 0 or 2. Meaning of the 0 – 2 settings: 0 = Error is not detected, 2 = Error |
| LAMP? | Lamp status query | Not supported |
| INST? | Input switch list query | Parameter Numbers 11 to 13 are depending on the slot installation condition 11: PC IN input (PC) When a single input terminal board is attached 11: SLOT input (SLOT INPUT) 12: PC IN input (PC) 21: VIDEO input (VIDEO) 31: HDMI input (HDMI) When a dual input terminal board is attached 11: SLOT input (SLOT INPUT A) 12: SLOT input (SLOT INPUT B) 13: PC IN input (PC) 22: COMPONENT/RGB IN input (COMPONENT) 32: DVI-D IN input (DVI) |
| NAME? | Projector name query | Returns empty character (no name information) |
| INF1? | Manufacturer name query | Returns "Panasonic" |
| INF2? | Model name query | Returns "TH-50PF30" (for 50-inch model) |
| INFO? | Other information query | Returns version number |
| CLSS? | Class information query | Returns "1" |

PJLink™ security authentication

Set "Panasonic" for the PJLink™ password.

- PJLink™ is a pending trademark in Japan, the United States, and other countries or areas.

Using Web Browser Control

You can use a Web browser to control the unit and set up a network and password.

Before Using Web Browser Control

To use the Web browser control, the unit and computer setups are required.

Unit Setup

Set each "Network Setup" setting and make sure to set the "Control I/F Select" to "LAN". (see page 52)

Computer Setup

Disable the proxy server settings and enable JavaScript.

(Windows)

Disable proxy server settings

- 1 Display [Internet Properties] window.
Click [Start] – [Control Panel] – [Network and Internet Connections] – [Internet Options].
- 2 Click the [Connections] tab and then [LAN Settings].
- 3 Deselect the [Use automatic configuration script] and [Use a proxy server for your LAN] boxes.
- 4 Click [OK].

Enable JavaScript

- 1 Display [Internet Properties] window.
Click [Start] – [Control Panel] – [Network and Internet Connections] – [Internet Options].
- 2 Set the security level on the [Security] tab to [Default Level]. Alternatively enable [Active scripting] from the [Custom Level] button.

(Macintosh)

Disable proxy server settings

- 1 From the [Safari] menu, click [Preferences].
General screen is displayed.
- 2 From the [Advanced] tab, click the [Change Settings...] button next to [Proxies]. Click [Proxies] and set up a proxy server.
- 3 Deselect the [Web Proxy] and [Automatic Proxy Configuration] boxes.
- 4 Click [Apply Now].

Enable JavaScript

- 1 Display [Security] of Safari.
- 2 Select [Enable JavaScript] under [Web content].

Access from Web Browser

Access to the TOP screen of the Web browser control using a Web browser.

- 1 Start your Web browser.
- 2 Enter the IP address set with the "Network Setup" of the unit. (see page 52)

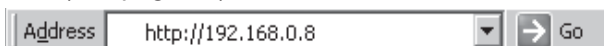

Address http://192.168.0.8 Go

- 3 Enter the user name and password when the Authentication screen is displayed.

Authentication screen

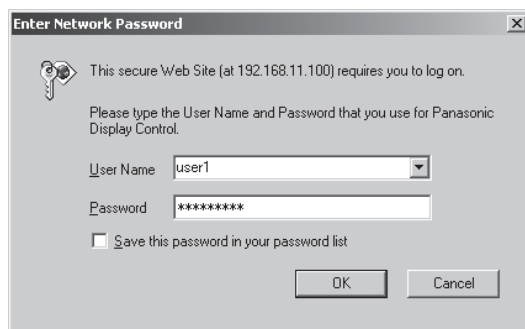

Enter Network Password

This secure Web Site (at 192.168.11.100) requires you to log on.
Please type the User Name and Password that you use for Panasonic Display Control.

User Name user1

Password *****

Save this password in your password list

OK Cancel

- 4 Click [OK].
After logged in, the TOP screen of the Web browser control is displayed. (see page 63)

Notes:

- The password used here is the same password used for command control and the PJLink™ security authentication.
- Default user name and password are as follows:
User name: user1
Password: Panasonic
- The password can be changed on the Password Setup screen after logging in (see page 64). The user name cannot be changed.
- Under no circumstances, Panasonic Corporation or its associated companies will ask customers their password directly.
Even if you are asked directly, please do not reveal your password.

TOP screen structure of the Web browser control

After logging in, the TOP screen of the Web browser control is displayed.

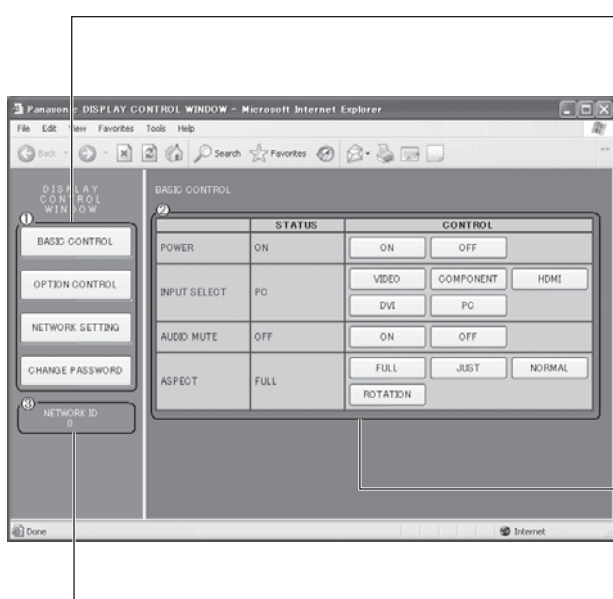

① **Menu**

Menu items are displayed. When a button is clicked, setup screen of each item is displayed.

| Item | Details |
|-----------------|---|
| BASIC CONTROL | BASIC CONTROL screen is displayed. (see below) |
| OPTION CONTROL | OPTION CONTROL screen is displayed. (see below) |
| NETWORK SETTING | Network Setup screen is displayed. (see page 64) |
| CHANGE PASSWORD | Password setup screen is displayed. (see page 64) |

② According to the selected item from the main menu, setup status or set items are displayed.

③ **Network ID information**

ID to identify the unit is displayed.

Display Control (BASIC CONTROL/OPTION CONTROL Screen)

Click BASIC CONTROL or OPTION CONTROL from the menu. Various controls of the unit can be set.

BASIC CONTROL screen

Click BASIC CONTROL from the menu. Unit status and buttons to change settings are displayed.

| | STATUS | CONTROL |
|--------------|--------|--------------------------------|
| POWER | ON | ON OFF |
| INPUT SELECT | PC | VIDEO COMPONENT HDMI DVI PC |
| AUDIO MUTE | OFF | ON OFF |
| ASPECT | FULL | FULL JUST NORMAL ROTATION |

| Item | Details |
|--------------|--|
| POWER | Switch ON/OFF of the unit power. |
| INPUT SELECT | Switch the input signals. Displayed buttons vary according to the connection status of the video device. |
| AUDIO MUTE | Switch ON/OFF of the sound mute. |
| ASPECT | Switch the screen modes |

OPTION CONTROL screen

Click OPTION CONTROL from the menu. Command input field for command control of the unit is displayed.



| Item | Details |
|----------|--|
| COMMAND | Enter a command. Use the same command used for the serial control. (see page 14) |
| RESPONSE | Response from the unit is displayed. |
| SEND | Command is sent and run. |

Note:

After the settings are changed, it may take a while till the display status is displayed.

NETWORK SETTING (Network Setup Screen)

Click NETWORK SETTING from the menu. Various settings of a network can be set. For the details of the setting items, please check Network Setup under the Set up of the unit. (see page 52)

| | |
|-------------|--|
| DHCP | <input checked="" type="radio"/> OFF <input type="radio"/> ON |
| IP ADDRESS | 192.168.0.8 |
| SUBNET MASK | 255.255.255.0 |
| GATEWAY | 192.168.0.1 |
| PORT | 1024 |
| LAN SPEED | <input type="radio"/> AUTO <input type="radio"/> 10 HALF <input type="radio"/> 10 FULL <input type="radio"/> 100 HALF <input type="radio"/> 100 FULL |
| NETWORK ID | 0 |

Notes:

- To use a DHCP server, make sure the DHCP server is started.
- During a DHCP server is used, IP ADDRESS, SUBNET MASK, and GATEWAY values cannot be entered.
- When the set values are changed properly, "NETWORK SETTING CHANGED." message and the changed set items are displayed.

| Item | Details |
|-------------|--|
| DHCP | Set to ON when a DHCP server is used, or OFF when it is not used. |
| IP ADDRESS | Enter an IP address. |
| SUBNET MASK | Enter a subnet mask. |
| GATEWAY | Enter a gateway address. |
| PORT | Enter the port number used for command control. The available setting range is 1024 - 65535. |
| LAN SPEED | Set the connection speed of the LAN environment. |
| NETWORK ID | Set the ID to identify this unit. The available setting range is 0 - 99. |
| SAVE | Save the each set value. |

Password Setting (Password Setup Screen)

Click CHANGE PASSWORD from the menu. Password to access the Web browser control can be set. When the password is changed in this screen, the password used for command control and the PJLink™ security authentication is also changed.

| | |
|-----------------------|-------|
| OLD PASSWORD | |
| NEW PASSWORD | |
| NEW PASSWORD (RETYPE) | |









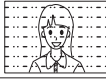

Notes:

- The default password is "Panasonic".
- Up to 32 alphanumeric characters can be used for a password.
- When the password is changed properly, "Password has changed." message is displayed.

| Item | Details |
|-----------------------|---|
| OLD PASSWORD | Enter the old password. |
| NEW PASSWORD | Enter the new password. |
| NEW PASSWORD (RETYPE) | Enter the password entered in "NEW PASSWORD" for confirmation. |
| SAVE | Save the new password. The confirmation screen is displayed. Click OK to change the password. |

Troubleshooting

Before you call for service, determine the symptoms and make a few simple checks as shown below.

| Symptoms | | Checks |
|--|--|---|
| Picture | Sound | |
|  Interference |  Noisy Sound | Electrical Appliances Cars / Motorcycles Fluorescent light |
|  Normal Picture |  No Sound | Volume (Check whether the mute function has been activated on the remote control.) |
|  No Picture |  No Sound | Not plugged into AC outlet Not switched on Picture and Brightness/Volume setting (Check by pressing the power switch or stand-by button on the remote control.) |
|  No Picture |  Normal Sound | If there is nothing wrong with the picture or sound, this is the sound of the cabinet undergoing very slight contractions in response to changes in the room temperature. There are no adverse effects on the performance or other aspects. |
|  No Colour |  Normal Sound | Colour controls set at minimum level (see page 28, 29) Colour system (see page 49) |
| No remote control operations can be performed. | | Check whether the batteries have discharged completely and, if they have not, whether they were inserted properly. Check whether the remote control sensor is exposed to an outdoor light or a strong fluorescent light. Check whether the remote control designed specifically for use with the unit is being used. (The unit cannot be operated by any other remote control.) |
| A cracking sound is sometimes heard from the unit. | | If there is nothing wrong with the picture or sound, this is the sound of the cabinet undergoing very slight contractions in response to changes in the room temperature. There are no adverse effects on the performance or other aspects. |
| The top or bottom of the picture on the screen is cut off when I use the zoom function. | | Adjust the position of the picture on the screen. |
| Areas at the top and bottom of the screen where the image is missing appear when I use the zoom function. | | When using a video software program (such as a cinema size program) with a screen wider than one in the 16:9 mode, blank areas separate from the images are formed at the top and bottom of the screen. |
| I can hear sounds coming from inside the unit. | | When the power is turned on, a sound of the display panel being driven may be heard: This is normal and not indicative of malfunctioning. |
| Parts of the unit become hot. | | Even when the temperature of parts of the front, top and rear panels has risen, these temperature rises will not pose any problems in terms of performance or quality. |
| Power automatically turns off unexpectedly. | | Check the settings of "PC Power management", "DVI-D Power management", "No signal power off" and "No activity power off" in the Setup menu. Any of them may be set to "On (Enable)". (see page 41) |
| Power indicator is blinking in red. | | There is possibility of malfunction. Please contact an Authorized Service Center. |
| This Plasma Display uses special image processing. Hence a slight time lag may occur between image and audio, depending on the type of input signal. However, this is not a malfunction. | | |

Plasma Display panel

| Symptoms | Check |
|--|--|
| The screen darkens slightly when bright pictures with minimal movements are shown. | The screen will darken slightly when photos, still images of a computer or other pictures with minimal movements are shown for an extended period. This is done to reduce image retention on the screen and the shortening of the screen's service life: It is normal and not indicative of malfunctioning. |
| It takes a while for the picture to appear. | The unit digitally processes the various signals in order to reproduce esthetically pleasing images. As such, it sometimes takes a few moments for the picture to appear when the power has been turned on, when the input has been switched. |
| The edges of the images flicker. | Due to the characteristics of the system used to drive the panel, the edges may appear to flicker in the fast-moving parts of the images: This is normal and not indicative of malfunctioning. |
| The brightness on both sides of images in the 4:3 mode changes. | When viewing the side panels at the "High" or "Mid" setting, the brightness on both sides may change depending on the kind of program shown: This is normal and not indicative of malfunctioning. |
| Some parts of the screen do not light up. | The plasma display panel is manufactured using an extremely high level of precision technology, however, sometimes some parts of the screen may be missing picture elements or have luminous spots. This is not a malfunction. |
|  Image retention appears | Do not allow a still picture to be displayed for an extended period, as this can cause a permanent image retention to remain on the Plasma Display. Examples of still pictures include logos, video games, computer images, teletext and images displayed in 4:3 mode. Note: The permanent image retention on the Plasma Display resulting from fixed image use is not an operating defect and as such is not covered by the Warranty. This product is not designed to display fixed images for extended periods of time. |
| Whirring sounds can be heard from the display unit. | The display unit is fitted with a cooling fan to dissipate heat generated during normal use. The whirring sound is caused by rotation of the fan and is not a malfunction. |

List of Aspect Modes

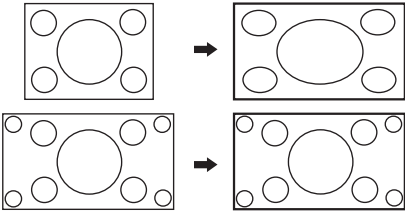
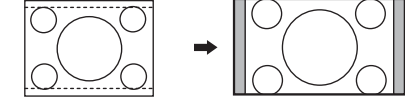
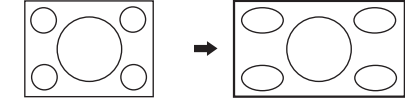
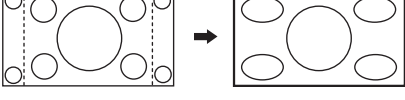
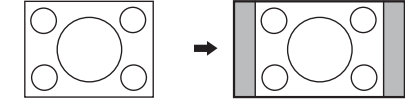
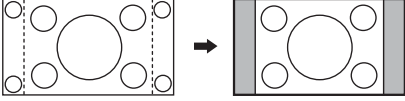
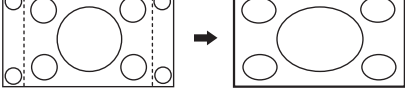
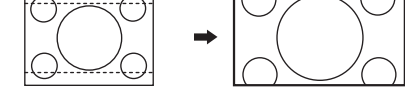
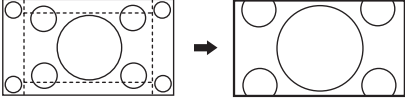
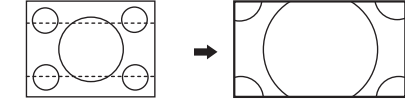
| Aspect mode | | Picture → Enlarged screen | Description |
|-------------------------|------------------------------------|---|---|
| All Aspect: On | Factory setting All Aspect: Off | | |
| 16:9 | 16:9 |  | The display of the pictures fills the screen. In the case of SD signals, pictures with a 4:3 aspect ratio are enlarged horizontally, and displayed. This mode is suited to displaying anamorphic pictures with a 16:9 aspect ratio. |
| 14:9 | 14:9 |  | Letterbox pictures with a 14:9 aspect ratio are enlarged vertically and horizontally so that their display fills the screen vertically and is slightly smaller than the screen horizontally. The top and bottom edges of the pictures are cut off. Side panels are displayed at the left and right edges of the screen. |
| Just ----- Just1 | Just |  | Pictures with a 4:3 aspect ratio are enlarged horizontally so that the picture distortion is minimized. The display of the areas around the left and right edges of the screen is slightly elongated. |
| Just2 | – |  | The pictures with a 4:3 aspect ratio among the 16:9 aspect ratio signals are enlarged horizontally so that the picture distortion is minimized. The left and right edges of the pictures are cut off. The display of the areas around the left and right edges of the screen is slightly elongated. |
| 4:3 ----- 4:3 (1) | 4:3 |  | Pictures with a 4:3 aspect ratio are displayed with their original aspect ratio. Side panels are displayed at the left and right edges of the screen. |
| 4:3 (2) | – |  | The pictures with a 4:3 aspect ratio among the 16:9 aspect ratio signals are displayed with their original aspect ratio. The left and right edges of the pictures are masked with side panels. |
| 4:3 Full | 4:3 Full |  | The pictures with a 4:3 aspect ratio among the 16:9 aspect ratio signals are enlarged horizontally so that their display fills the screen. The left and right edges of the pictures are cut off. |
| Zoom ----- Zoom1 | Zoom1 |  | Letterbox pictures with a 16:9 aspect ratio are enlarged vertically and horizontally so that their display fills the screen. The top and bottom edges of the pictures are cut off. |
| Zoom2 | Zoom2 |  | The letterbox pictures with a 2.35:1 aspect ratio among the 16:9 aspect ratio signals are enlarged vertically and horizontally so that their display fills the screen. The top and bottom edges as well as the left and right edges of the pictures are cut off. |
| Zoom3 | Zoom3 |  | Letterbox pictures with a 2.35:1 aspect ratio are enlarged vertically and horizontally so that their display fills the screen vertically and is slightly larger than the screen horizontally. The top and bottom edges as well as the left and right edges of the pictures are cut off. |

Applicable Input Signals

*Mark: Applicable input signal

| | Signal name | Horizontal frequency (kHz) | Vertical frequency (Hz) | COMPONENT / RGB IN / PC IN (Dot clock (MHz)) | DVI-D IN (Dot clock (MHz)) | HDMI |
|----|----------------------------|----------------------------|-------------------------|--|----------------------------|------|
| 1 | 525 (480) / 60i | 15.73 | 59.94 | * (13.5) | * (27.0) | * |
| 2 | 525 (480) / 60p | 31.47 | 59.94 | * (27.0) *5 | * (27.0) | * |
| 3 | 625 (575) / 50i | 15.63 | 50.00 | * (13.5) | | |
| 4 | 625 (576) / 50i | 15.63 | 50.00 | | * (27.0) | * |
| 5 | 625 (575) / 50p | 31.25 | 50.00 | * (27.0) | | |
| 6 | 625 (576) / 50p | 31.25 | 50.00 | | * (27.0) | * |
| 7 | 750 (720) / 60p | 45.00 | 60.00 | * (74.25) | * (74.25) | * |
| 8 | 750 (720) / 50p | 37.50 | 50.00 | * (74.25) | * (74.25) | * |
| 9 | 1,125 (1,080) / 60p | 67.50 | 60.00 | * (148.5) *1 | * (148.5) | * |
| 10 | 1,125 (1,080) / 60i | 33.75 | 60.00 | * (74.25) *1 | * (74.25) | * |
| 11 | 1,125 (1,080) / 50p | 56.26 | 50.00 | * (148.5) *1 | * (148.5) | * |
| 12 | 1,125 (1,080) / 50i | 28.13 | 50.00 | * (74.25) *1 | * (74.25) | * |
| 13 | 1,125 (1,080) / 24sF | 27.00 | 48.00 | * (74.25) *2 | | |
| 14 | 1,125 (1,080) / 30p | 33.75 | 30.00 | * (74.25) *1 | * (74.25) | |
| 15 | 1,125 (1,080) / 25p | 28.13 | 25.00 | * (74.25) *1 | * (74.25) | |
| 16 | 1,125 (1,080) / 24p | 27.00 | 24.00 | * (74.25) *1 | * (74.25) | * |
| 17 | 1,250 (1,080) / 50i | 31.25 | 50.00 | * (74.25) *3 | | |
| 18 | 2,048 × 1,080 / 24sF *7 | 27.00 | 48.00 | | | |
| 19 | 2,048 × 1,080 / 24p *7 | 27.00 | 24.00 | | | |
| 20 | 640 × 400 @70 Hz | 31.46 | 70.07 | * (25.17) | | |
| 21 | 640 × 480 @60 Hz | 31.47 | 59.94 | * (25.18) *6 | * (25.18) | * |
| 22 | 640 × 480 @72 Hz | 37.86 | 72.81 | * (31.5) | | |
| 23 | 640 × 480 @75 Hz | 37.50 | 75.00 | * (31.5) | | |
| 24 | 640 × 480 @85 Hz | 43.27 | 85.01 | * (36.0) | | |
| 25 | 800 × 600 @56 Hz | 35.16 | 56.25 | * (36.0) | | |
| 26 | 800 × 600 @60 Hz | 37.88 | 60.32 | * (40.0) | * (40.0) | * |
| 27 | 800 × 600 @72 Hz | 48.08 | 72.19 | * (50.0) | | |
| 28 | 800 × 600 @75 Hz | 46.88 | 75.00 | * (49.5) | | |
| 29 | 800 × 600 @85 Hz | 53.67 | 85.06 | * (56.25) | | |
| 30 | 852 × 480 @60 Hz | 31.47 | 59.94 | * (33.54) *6 | * (34.24) | * |
| 31 | 1,024 × 768 @50 Hz | 39.55 | 50.00 | | * (51.89) | * |
| 32 | 1,024 × 768 @60 Hz | 48.36 | 60.00 | * (65.0) | * (65.0) | * |
| 33 | 1,024 × 768 @70 Hz | 56.48 | 70.07 | * (75.0) | | |
| 34 | 1,024 × 768 @75 Hz | 60.02 | 75.03 | * (78.75) | | |
| 35 | 1,024 × 768 @85 Hz | 68.68 | 85.00 | * (94.5) | | |
| 36 | 1,066 × 600 @60 Hz | 37.64 | 59.94 | * (53.0) | * (53.0) | * |
| 37 | 1,152 × 864 @60 Hz | 53.70 | 60.00 | | * (81.62) | * |
| 38 | 1,152 × 864 @75 Hz | 67.50 | 75.00 | * (108.0) | | |
| 39 | 1,280 × 768 @60 Hz | 47.70 | 60.00 | * (80.14) | | |
| 40 | 1,280 × 960 @60 Hz | 60.00 | 60.00 | * (108.0) | | |
| 41 | 1,280 × 960 @85 Hz | 85.94 | 85.00 | * (148.5) | | |
| 42 | 1,280 × 1,024 @60 Hz | 63.98 | 60.02 | * (108.0) | * (108.0) | * |
| 43 | 1,280 × 1,024 @75 Hz | 79.98 | 75.03 | * (135.0) | | |
| 44 | 1,280 × 1,024 @85 Hz | 91.15 | 85.02 | * (157.5) | | |
| 45 | 1,366 × 768 @50 Hz | 39.55 | 50.00 | | * (69.92) | * |
| 46 | 1,366 × 768 @60 Hz | 48.36 | 60.00 | * (86.71) | * (87.44) | * |
| 47 | 1,400 × 1,050 @60 Hz | 65.22 | 60.00 | | * (122.61) | * |
| 48 | 1,600 × 1,200 @60 Hz | 75.00 | 60.00 | * (162.0) | * (162.0) | * |
| 49 | 1,600 × 1,200 @65 Hz | 81.25 | 65.00 | * (175.5) | | |
| 50 | 1,920 × 1,080 @60 Hz | 67.50 | 60.00 | * (148.5) *4 | * (148.5) | * |
| 51 | 1,920 × 1,200 @60 Hz | 74.04 | 59.95 | | * (154.0) | * |
| 52 | Macintosh13" (640 × 480) | 35.00 | 66.67 | * (30.24) | | |
| 53 | Macintosh16" (832 × 624) | 49.72 | 74.54 | * (57.28) | | |
| 54 | Macintosh21" (1,152 × 870) | 68.68 | 75.06 | * (100.0) | | |

*1: Based on SMPTE 274M standard.

*2: Based on SMPTE RP211 standard.

*3: Based on SMPTE 295M standard.

*4: The input signal is recognized as 1,125 (1,080) / 60p.

*5: When selected the RGB format and 525p signal input to the PC IN terminal, it is recognized as VGA 60Hz signal.

*6: When inputted VGA 60Hz format signal from the other than PC IN terminal, it is recognized as 525p signal.

*7: Based on SMPTE 292M and 372M standards. These signals can be received when the Dual Link HD-SDI Terminal Board (TY-FB11DHD) is installed.

Note: Signals without above specification may not be displayed properly.

Applicable Input Signals

Video input (VIDEO)

| | Signal name | Horizontal frequency(kHz) | Vertical frequency(Hz) |
|---|---------------|---------------------------|------------------------|
| 1 | NTSC | 15.73 | 59.94 |
| 2 | PAL | 15.63 | 50.00 |
| 3 | PAL60 | 15.73 | 59.94 |
| 4 | SECAM | 15.63 | 50.00 |
| 5 | Modified NTSC | 15.73 | 59.94 |

Shipping condition

This function allows you to reset the unit to the factory setting.

1  Press to display the Setup menu.

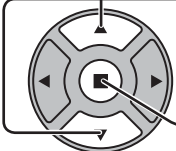
2  Press to select "OSD Language".
Press for more than 3 seconds.

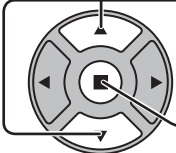
3  Press to select "Shipping".
Press to display the Shipping menu.

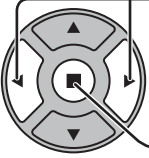
4  Press to select "YES".
Press to confirm.

5 Wait for 10 seconds.

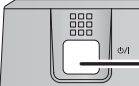
6  Press the power switch (⏻/⏻) on main unit to turn the power off.

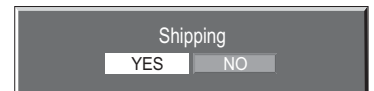
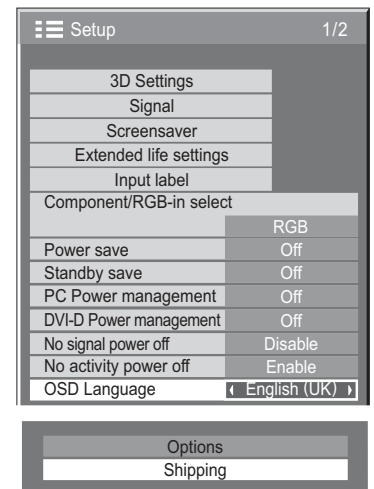

[from the unit]

- 1 Press the MENU button till the Setup menu is displayed.
- 2 Press the Volume Up "+" or Down "-" button to select "OSD Language".
- 3 Press and hold the ENTER button till the Shipping menu is displayed.
- 4 Press the Volume Up "+" or Down "-" button to select "YES".
- 5 Press the ENTER button and wait for 10 sec.
- 6 Press the power switch (⏻/⏻) on main unit to turn the power off.

Command list of Weekly Command Timer

| No. | Command | Control details |
|-----|------------|--|
| 1 | AAC:MENCLR | Audio Menu (Clear) |
| 2 | AAC:MENDYN | Audio Menu (Dynamic) |
| 3 | AAC:MENSTD | Audio Menu (Standard) |
| 4 | AAC:SURMON | Surround (ON) |
| 5 | AAC:SUROFF | Surround (OFF) |
| 6 | AMT:0 | Audio Mute (OFF) |
| 7 | AMT:1 | Audio Mute (ON) |
| 8 | - | - |
| 9 | - | - |
| 10 | AVL:00 | Audio Volume (00) |
| 11 | AVL:10 | Audio Volume (10) |
| 12 | AVL:20 | Audio Volume (20) |
| 13 | AVL:30 | Audio Volume (30) |
| 14 | AVL:40 | Audio Volume (40) |
| 15 | AVL:50 | Audio Volume (50) |
| 16 | AVL:60 | Audio Volume (60) |
| 17 | DAM:FULL | Aspect (16:9) |
| 18 | DAM:JUST | Aspect (Just) |
| 19 | DAM:NORM | Aspect (4:3) |
| 20 | - | - |
| 21 | DAM:ZOOM | Aspect (Zoom) |
| 22 | - | - |
| 23 | - | - |
| 24 | - | - |
| 25 | - | - |
| 26 | - | - |
| 27 | - | - |
| 28 | - | - |
| 29 | - | - |
| 30 | - | - |
| 31 | - | - |
| 32 | - | - |
| 33 | - | - |
| 34 | - | - |
| 35 | - | - |
| 36 | - | - |
| 37 | - | - |
| 38 | - | - |
| 39 | IMS:SL1 | Input select (SLOT INPUT) |
| 40 | IMS:S1A | Input select (SLOT INPUT A) |
| 41 | IMS:S1B | Input select (SLOT INPUT B) |
| 42 | IMS:VD1 | Input select (VIDEO) |
| 43 | IMS:YP1 | Input select (COMPONENT) |
| 44 | IMS:HM1 | Input select (HDMI) |
| 45 | IMS:DV1 | Input select (DVI) |
| 46 | IMS:PC1 | Input select (PC) |
| 47 | - | - |
| 48 | - | - |
| 49 | - | - |
| 50 | - | - |
| 51 | - | - |
| 52 | - | - |
| 53 | - | - |
| 54 | - | - |
| 55 | OSP:SCR0 | Screen Saver Scrolling bar only (OFF) |
| 56 | OSP:SCR1 | Screen Saver Scrolling bar only (ON) |
| 57 | POF | Power OFF |
| 58 | PON | Power ON |
| 59 | SSC:FNC0 | Screen Saver function (Scrolling bar only) |
| 60 | SSC:FNC1 | Screen Saver function (Negative image) |
| 61 | SSC:MOD0 | Screen Saver (Mode (OFF)) |
| 62 | SSC:MOD3 | Screen Saver (Mode (ON)) |
| 63 | VMT:0* | Picture Mute (OFF) |
| 64 | VMT:1* | Picture Mute (ON) |

* Picture Mute cannot be unlocked by powering off/on with the remote control. Turn off and on again with the button on the unit or enter the command VMT:0 to unlock Picture Mute.

Specifications

| | TH-42PF30ER | TH-50PF30ER |
|-------------------------------|--|--|
| Power Source | 220 - 240 V AC, 50/60 Hz | |
| Power Consumption | | |
| Power on | 365 W | 445 W |
| Stand-by condition | Save off 0.8 W, Save on 0.5 W | Save off 0.8 W, Save on 0.5 W |
| Power off condition | 0.3 W | 0.3 W |
| Plasma Display panel | Drive method : AC type 42-inch, 16:9 aspect ratio | Drive method : AC type 50-inch, 16:9 aspect ratio |
| Screen size | 921 mm (W) × 518 mm (H) × 1,057 mm (diagonal) | 1,105 mm (W) × 622 mm (H) × 1,268 mm (diagonal) |
| (No. of pixels) | 2,073,600 (1,920 (W) × 1,080 (H)) [5,760 × 1,080 dots] | |
| Operating condition | | |
| Temperature | 0 °C - 40 °C | |
| Humidity | 20 % - 80 % | |
| Applicable signals | | |
| Colour System | NTSC, PAL, PAL60, SECAM, Modified NTSC | |
| Scanning format | 525 (480) / 60i · 60p, 625 (575) / 50i · 50p, 750 (720) / 60p · 50p, 1125 (1080) / 60i · 60p · 50i · 50p · 24p · 25p · 30p · 24sF, 1250 (1080) / 50i | |
| PC signals | VGA, SVGA, XGA, SXGA UXGA (compressed) Horizontal scanning frequency 15 - 110 kHz Vertical scanning frequency 48 - 120 Hz | |
| Connection terminals | | |
| LAN | RJ45 10BASE-T/100BASE-TX, compatible with PLink™ | |
| AV IN | VIDEO | BNC 1.0 Vp-p (75 Ω) |
| | AUDIO L-R | RCA Pin jack × 2 0.5 Vrms |
| | HDMI | TYPE A Connector |
| COMPONENT/RGB IN | | |
| | Y/G | BNC with sync 1.0 Vp-p (75 Ω) |
| | PB/CB/B | BNC 0.7 Vp-p (75 Ω) |
| | PR/CR/R | BNC 0.7 Vp-p (75 Ω) |
| | AUDIO L-R | RCA Pin jack × 2 0.5 Vrms |
| DVI-D IN | | DVI-D 24 Pin Content Protection Compliance with DVI Revision 1.0 Compatible with HDCP 1.1 |
| | AUDIO | Stereo mini jack (M3) × 1 0.5 Vrms, Shared with PC IN |
| PC IN | | High-Density Mini D-sub 15 Pin Y or G with sync 1.0 Vp-p (75 Ω) Y or G without sync 0.7 Vp-p (75 Ω) PB/CB/B: 0.7 Vp-p (75 Ω) PR/CR/R: 0.7 Vp-p (75 Ω) HD/VD: 1.0 - 5.0 Vp-p (high impedance) with picture 1.0 Vp-p (high impedance) without picture 0.3 Vp-p (high impedance) 0.5 Vrms, Shared with DVI-D IN |
| | AUDIO | Stereo mini jack (M3) × 1 |
| SERIAL | External Control Terminal D-sub 9 Pin | RS-232C compatible |
| 3D IR TRANSMITTER | for 3D IR TRANSMITTER | |
| | 3D SHUTTER OUT | M3 jack × 1 |
| | DC 8V OUT | Center plus, for EIAJ 4mm plug |
| EXT SP | Speaker Terminal | 6 Ω, 16 W [8 W + 8 W] (10 % THD) |
| Dimensions (W × H × D) | 1,020 mm × 610 mm × 89 mm | 1,210 mm × 724 mm × 89 mm |
| Mass (weight) | | |
| main unit only | approx. 25.5 kg net | approx. 33.0 kg net |
| with speakers | approx. 29.5 kg | approx. 38.0 kg |

Notes:

- Design and specifications are subject to change without notice. Mass and dimensions shown are approximate.
- This equipment complies with the EMC standards listed below.
EN55022, EN55024, EN61000-3-2, EN61000-3-3.

Information for Users on Collection and Disposal of Old Equipment and used Batteries



These symbols on the products, packaging, and/or accompanying documents mean that used electrical and electronic products and batteries should not be mixed with general household waste. For proper treatment, recovery and recycling of old products and used batteries, please take them to applicable collection points, in accordance with your national legislation and the Directives 2002/96/EC and 2006/66/EC.

By disposing of these products and batteries correctly, you will help to save valuable resources and prevent any potential negative effects on human health and the environment which could otherwise arise from inappropriate waste handling.

For more information about collection and recycling of old products and batteries, please contact your local municipality, your waste disposal service or the point of sale where you purchased the items. Penalties may be applicable for incorrect disposal of this waste, in accordance with national legislation.

For business users in the European Union

If you wish to discard electrical and electronic equipment, please contact your dealer or supplier for further information.

[Information on Disposal in other Countries outside the European Union]

These symbols are only valid in the European Union. If you wish to discard these items, please contact your local authorities or dealer and ask for the correct method of disposal.

Note for the battery symbol (bottom two symbol examples):

This symbol might be used in combination with a chemical symbol. In this case it complies with the requirement set by the Directive for the chemical involved.



Cd

<Software Information for This Product>

This product has software installed partially licensed under the Free BSD LICENSE.

Free BSD LICENSE regulations under the above specifications are as follows:

(These regulations are set by the third party; therefore the original (English) regulations are stated.)

Copyright © 1980, 1986, 1993

The Regents of the University of California. All rights reserved.

Redistribution and use in source and binary forms, with or without modification, are permitted provided that the following conditions are met:

1. Redistributions of source code must retain the above copyright notice, this list of conditions and the following disclaimer.
2. Redistributions in binary form must reproduce the above copyright notice, this list of conditions and the following disclaimer in the documentation and/or other materials provided with the distribution.
3. All advertising materials mentioning features or use of this software must display the following acknowledgement:
This product includes software developed by the University of California, Berkeley and its contributors.
4. Neither the name of the University nor the names of its contributors may be used to endorse or promote products derived from this software without specific prior written permission.

THIS SOFTWARE IS PROVIDED BY THE REGENTS AND CONTRIBUTORS "AS IS" AND ANY EXPRESS OR IMPLIED WARRANTIES, INCLUDING, BUT NOT LIMITED TO, THE IMPLIED WARRANTIES OF MERCHANTABILITY AND FITNESS FOR A PARTICULAR PURPOSE ARE DISCLAIMED. IN NO EVENT SHALL THE REGENTS OR CONTRIBUTORS BE LIABLE FOR ANY DIRECT, INDIRECT, INCIDENTAL, SPECIAL, EXEMPLARY, OR CONSEQUENTIAL DAMAGES (INCLUDING, BUT NOT LIMITED TO, PROCUREMENT OF SUBSTITUTE GOODS OR SERVICES; LOSS OF USE, DATA, OR PROFITS; OR BUSINESS INTERRUPTION) HOWEVER CAUSED AND ON ANY THEORY OF LIABILITY, WHETHER IN CONTRACT, STRICT LIABILITY, OR TORT (INCLUDING NEGLIGENCE OR OTHERWISE) ARISING IN ANY WAY OUT OF THE USE OF THIS SOFTWARE, EVEN IF ADVISED OF THE POSSIBILITY OF SUCH DAMAGE.

Customer's Record

The model number and serial number of this product can be found on its rear panel. You should note this serial number in the space provided below and retain this book, plus your purchase receipt, as a permanent record of your purchase to aid in identification in the event of theft or loss, and for Warranty Service purposes.

Model Number _____

Serial Number _____

Panasonic Corporation

Web Site : <http://panasonic.net>

© Panasonic Corporation 2011