

CHRISTIE LX25

MODEL 38-VIV208-01

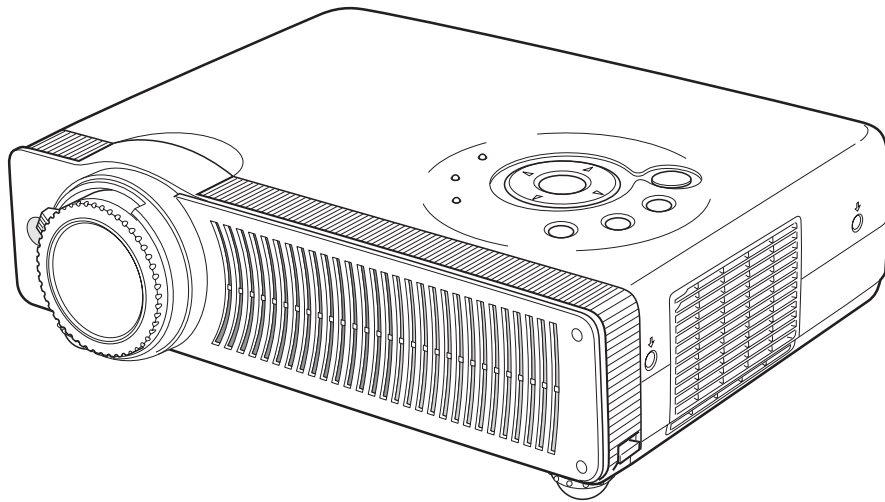

User's Manual

Table of Contents

Table of Contents	2	Computer Input	24
To the User	3	Input Source Selection	24
Safety Instructions	4	Computer System Selection	25
Installing the Projector in Proper Position	5	Computer Adjustment (Auto)	26
Air Circulation	5	Computer Adjustment (Manual)	27
Moving the Projector	5	Image Level Selection	29
Compliance	6	Image Level Adjustment	30
Connecting the AC Power Cord	7	Screen Size Adjustment	31
Features and Design	8	Video Input	32
Part Names and Functions	9	Input Source Selection (Video, S-Video)	32
Front	9	Input Source Selection (Component, RGB Scart 21-Pin)	33
Back	9	Video System Selection	34
Bottom	9	Image Level Selection	35
Terminal	10	Image Level Adjustment	36
Top	11	Screen Size Adjustment	37
Remote Control	12	Setting	38
Laser Pointer Function	13	Setting	38
Pointer Function	13	Maintenance and Cleaning	41
Remote Control Code	14	Warning Indicator	41
Wireless Mouse Operation	14	Cleaning the Air Filters	42
Remote Control Operating Range	15	Cleaning the Projection Lens	42
Remote Control Batteries Installation	15	Cleaning the Projector Cabinet	42
Installation	16	Lamp Replacement	43
Positioning the Projector	16	Lamp Replace Counter	44
Adjustable Feet	16	Appendix	45
Connecting to a Computer	17	Troubleshooting	45
Connecting to Video Equipment	18	Indicators and Projector Condition	47
Basic Operation	19	Menu Tree	48
Turning On the Projector	19	Compatible Computer Specifications	50
Turning Off the Projector	19	Technical Specifications	51
Zoom Adjustment	20	Configurations of Terminals	52
Focus Adjustment	20	Optional Parts	53
Keystone Adjustment	20	Attaching the Lens Cover	54
Picture Freeze Function	20		
No Show Function	21		
P-Timer Function	21		
Sound Adjustment	21		
On-Screen Menu	22		
Menu Bar	23		

TRADEMARKS





- Apple, Macintosh, and PowerBook are trademarks or registered trademarks of Apple Computer, Inc.
- IBM, VGA, XGA, and PS/2 are trademarks or registered trademarks of International Business Machines, Inc.
- Windows and PowerPoint are registered trademarks of Microsoft Corporation.
- Each name of corporations or products in the user's manual is a trademark or a registered trademark of its respective corporation.

Before operating this projector, read this manual thoroughly and operate the projector properly.

This projector provides many convenient features and functions. Operating the projector properly enables you to manage those features and maintains it in better condition for a considerable time.

Improper operation may result in not only shortening the product-life, but also malfunctions, fire hazard, or other accidents.

If your projector seems to operate improperly, read this manual again, check operations and cable connections and try the solutions in the "Troubleshooting" section at the end of this booklet. If the problem still persists, contact the dealer where you purchased the projector or the service center.

	CAUTION RISK OF ELECTRIC SHOCK DO NOT OPEN	
CAUTION : TO REDUCE THE RISK OF ELECTRIC SHOCK, DO NOT REMOVE COVER (OR BACK). NO USER-SERVICEABLE PARTS INSIDE EXCEPT LAMP REPLACEMENT. REFER SERVICING TO QUALIFIED SERVICE PERSONNEL.		
	THIS SYMBOL INDICATES THAT DANGEROUS VOLTAGE CONSTITUTING A RISK OF ELECTRIC SHOCK IS PRESENT WITHIN THIS UNIT.	
	THIS SYMBOL INDICATES THAT THERE ARE IMPORTANT OPERATING AND MAINTENANCE INSTRUCTIONS IN THE USER'S MANUAL WITH THIS UNIT.	



Safety Precaution

WARNING : TO REDUCE THE RISK OF FIRE OR ELECTRIC SHOCK, DO NOT EXPOSE THIS APPLIANCE TO RAIN OR MOISTURE.

- This projector produces intense light from the projection lens. Do not stare directly into the lens as possible. Eye damage could result. Be especially careful that children do not stare directly into the beam.
- Install the projector in a proper position. If not, it may result in a fire hazard.
- Provide appropriate space on the top, sides and rear of the projector cabinet for allowing air circulation and cooling the projector. Minimum clearance must be maintained. If the projector is to be built into a compartment or similarly enclosed, the minimum distances must be maintained. Do not cover the ventilation slot on the projector. Heat build-up can reduce the service life of your projector, and can also be dangerous.

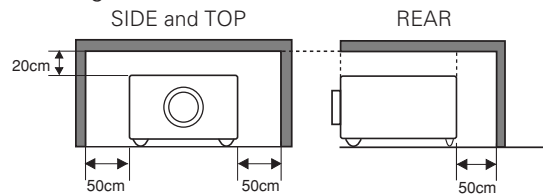

- The remote control, supplied to this projector, emits a laser beam as the Laser pointer function from laser light window while pressing the LASER button (for 1 minute / Signal Emission indicator lights red to indicate laser emission). Do not look into the laser light window or shine the laser beam on a mirror, yourself or other people. Eye damage may result.
- Do not put any flammable object or spray can near the projector, hot air is exhausted from the ventilation holes.
- If the projector is not to be used for an extended time, unplug the projector from the power outlet.

READ AND KEEP THIS USER'S MANUAL FOR LATER USE.

Safety Instructions

All the safety and operating instructions should be read before the product is operated.

Read all of the instructions given here and retain them for later use. Unplug this projector from AC power supply before cleaning. Do not use liquid or aerosol cleaners. Use a damp cloth for cleaning.

Follow all warnings and instructions marked on the projector.

For added protection to the projector during a lightning storm, or when it is left unattended and unused for long periods of time, unplug it from the wall outlet. This will prevent damage due to lightning and power line surges.

Do not expose this unit to rain or use near water... for example, in a wet basement, near a swimming pool, etc...

Do not use attachments not recommended by the manufacturer as they may cause hazards.

Do not place this projector on an unstable cart, stand, or table. The projector may fall, causing serious injury to a child or adult, and serious damage to the projector. Use only with a cart or stand recommended by the manufacturer, or sold with the projector. Wall or shelf mounting should follow the manufacturer's instructions, and should use a mounting kit approved by the manufacturers.

An appliance and cart combination should be moved with care. Quick stops, excessive force, and uneven surfaces may cause the appliance and cart combination to overturn.



Slots and openings in the back and bottom of the cabinet are provided for ventilation, to insure reliable operation of the equipment and to protect it from overheating.

The openings should never be covered with cloth or other materials, and the bottom opening should not be blocked by placing the projector on a bed, sofa, rug, or other similar surface. This projector should never be placed near or over a radiator or heat register.

This projector should not be placed in a built-in installation such as a book case unless proper ventilation is provided.

Never push objects of any kind into this projector through cabinet slots as they may touch dangerous voltage points or short out parts that could result in a fire or electric shock. Never spill liquid of any kind on the projector.

Do not install the projector near the ventilation duct of air-conditioning equipment.

This projector should be operated only from the type of power source indicated on the marking label. If you are not sure of the type of power supplied, consult your authorized dealer or local power company.

Do not overload wall outlets and extension cords as this can result in fire or electric shock. Do not allow anything to rest on the power cord. Do not locate this projector where the cord may be damaged by persons walking on it.

Do not attempt to service this projector yourself as opening or removing covers may expose you to dangerous voltage or other hazards. Refer all servicing to qualified service personnel.

Unplug this projector from wall outlet and refer servicing to qualified service personnel under the following conditions:

- a. When the power cord or plug is damaged or frayed.
- b. If liquid has been spilled into the projector.
- c. If the projector has been exposed to rain or water.
- d. If the projector does not operate normally by following the operating instructions. Adjust only those controls that are covered by the operating instructions as improper adjustment of other controls may result in damage and will often require extensive work by a qualified technician to restore the projector to normal operation.
- e. If the projector has been dropped or the cabinet has been damaged.
- f. When the projector exhibits a distinct change in performance-this indicates a need for service.

When replacement parts are required, be sure the service technician has used replacement parts specified by the manufacturer that have the same characteristics as the original part. Unauthorized substitutions may result in fire, electric shock, or injury to persons.

Upon completion of any service or repairs to this projector, ask the service technician to perform routine safety checks to determine that the projector is in safe operating condition.

Voor de klanten in Nederland



Bij dit product zijn batterijen geleverd. Wanneer deze leeg zijn, moet u ze niet weggooien maar inleveren als KCA.

Installing the Projector in Proper Position

Install the projector properly. Improper installation may reduce the lamp lifetime and cause a fire hazard.

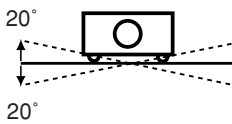

Do not tilt the projector more than 20 degrees above and below.



Do not put the projector on either side to project an image.

NO SIDEWAYS



Do not point the projector down to project an image.

NO DOWNWARD



Do not point the projector up to project an image.

NO UPWARD

Air Circulation

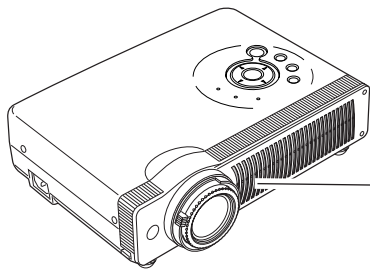

Air Intake Vent



CAUTION

Hot air is exhausted from the exhaust vent. When using or installing the projector, the following precautions should be taken.

- Do not put any flammable objects near the vent.
- Keep the exhaust vent at least 3'(1m) away from any objects.
- Do not touch a peripheral part of the exhaust vent, especially screws and metallic part. This area will become hot while the projector is being used.
- Do not put anything on the cabinet. The materials put on the cabinet will not only get damaged but also cause fire hazard by heat.

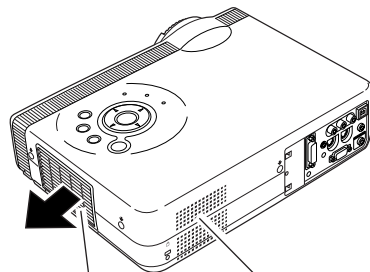

Exhaust Vent
(Hot air exhaust)

Air Intake Vent

Cooling fans are provided to cool down the projector. This projector monitors internal temperature and control the running speed of the cooling fans.

Moving the Projector

When moving the projector, replace the lens cover and retract the adjustable feet to prevent damage to the lens and cabinet. When the projector is not in use for an extended period, put it into the carrying bag supplied with the projector.

The carrying bag is intended for protection from dust and scratches on the surface of a cabinet, and it is not designed to protect the projector from external forces. Do not transport the projector through a courier or transport services with this bag. The projector can be damaged. When handling the projector, do not drop, bump, subject it to strong forces or put other things on the cabinet.



CAUTION IN CARRYING OR TRANSPORTING THE PROJECTOR

- Do not drop or bump the projector, otherwise damages or malfunctions may result.
- When carrying the projector, use a suitable carrying case.
- Do not transport the projector by using a courier or transport service in an unsuitable transport case. This may cause damage to the projector. To transport the projector through a courier or transport service, consult your dealer for best way.

Compliance

Federal Communication Commission Notice

Note : This equipment has been tested and found to comply with the limits for a Class B digital device, pursuant to part 15 of the FCC Rules. These limits are designed to provide reasonable protection against harmful interference in a residential installation. This equipment generates, uses and can radiate radio frequency energy and, if not installed and used in accordance with the instructions, may cause harmful interference to radio communications. However, there is no guarantee that interference will not occur in a particular installation. If this equipment does cause harmful interference to radio or television reception, which can be determined by turning the equipment off and on, the user is encouraged to try to correct the interference by one or more of the following measures :

- Reorient or relocate the receiving antenna.
- Increase the separation between the equipment and receiver.
- Connect the equipment into an outlet on a circuit different from that to which the receiver is connected.
- Consult the dealer or an experienced radio/TV technician for help.

Use of shielded cable is required to comply with class B limits in Subpart B of Part 15 of FCC Rules.

Do not make any changes or modifications to the equipment unless otherwise specified in the instructions. If such changes or modifications should be made, you could be required to stop operation of the equipment.

Model Number : 38-VIV208-01
Trade Name : Christie
Responsible party : CHRISTIE DIGITAL SYSTEMS, Inc.
Address : 10550 Camden Drive Cypress, CA 90630 USA
Telephone No. : (714) 236-8610

AC POWER CORD REQUIREMENT

The AC Power Cord supplied with this projector meets the requirement for use in the country you purchased it.

AC Power Cord for the United States and Canada :

AC Power Cord used in the United States and Canada is listed by the Underwriters Laboratories (UL) and certified by the Canadian Standard Association (CSA).

AC Power Cord has a grounding-type AC line plug. This is a safety feature to be sure that the plug will fit into the power outlet. Do not try to defeat this safety feature. Should you be unable to insert the plug into the outlet, contact your electrician.

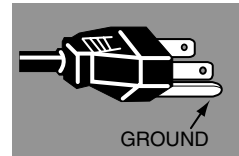

THE SOCKET-OUTLET SHOULD BE INSTALLED NEAR THE EQUIPMENT AND EASILY ACCESSIBLE.

Connecting the AC Power Cord

This projector uses nominal input voltages of 100-120 V or 200-240 V AC. This projector automatically selects the correct input voltage. It is designed to work with single-phase power systems having a grounded neutral conductor. To reduce risk of electrical shock, do not plug into any other type of power system.

Consult your authorized dealer or service station if you are not sure of the type of power being supplied.

Connect the projector with all peripheral equipment before turning the projector on. (See page 17-18 for connection.)



CAUTION

For safety, unplug AC power cord when the projector is not in use.

When this projector is connected to an outlet with AC power cord, it is in Stand-by mode and consumes a little electric power.

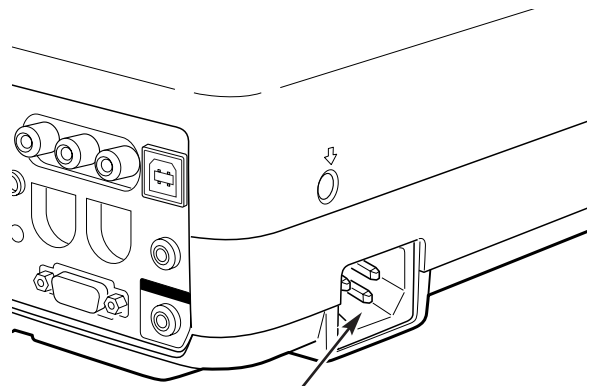

Connect AC power cord (supplied) to the projector. The AC outlet must be near this equipment and must be easily accessible.

NOTE ON THE POWER CORD

The AC Power Cord must meet the requirement of the country where you use the projector. Confirm the AC plug type with the chart below. The proper AC Power Cord must be used. If the supplied AC Power Cord does not match the AC outlet, contact your sales dealer.

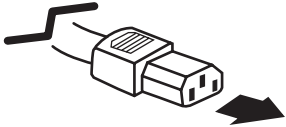
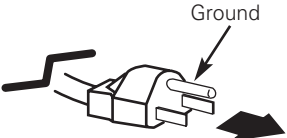
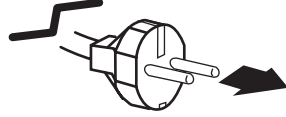
Projector side	AC Outlet side	
 <p data-bbox="381 1281 592 1354">To the POWER CORD CONNECTOR on the projector.</p>	<p data-bbox="673 1081 974 1113">For the U.S.A. and Canada</p>  <p data-bbox="836 1134 917 1155">Ground</p> <p data-bbox="803 1291 974 1344">To the AC Outlet. (120 V AC)</p>	<p data-bbox="1055 1081 1356 1113">For Continental Europe</p>  <p data-bbox="1177 1312 1364 1365">To the AC Outlet. (200 - 240 V AC)</p>

Features and Design

This Multimedia Projector is designed with the most advanced technology for portability, durability, and ease of use. This projector utilizes built-in multimedia features, a palette of 16.77 million colors, and matrix liquid crystal display (LCD) technology.

◆ Compact Design

This projector is extremely compact in size and weight. It is designed to be carried and work anywhere you wish to use.

◆ Compatibility

The projector widely accepts various video and computer input signals including;

- **Computers**
IBM-compatible or Macintosh computer up to 1280 x 1024 resolution.
- **6 Color Systems**
NTSC, PAL, SECAM, NTSC 4.43, PAL-M or PAL-N color system can be connected.
- **Component Video**
Component video signal, such as a DVD player output high definition TV signals including 480i, 480p, 575i, 575p, 720p, 1035i or 1080i, can be connected.
- **S-Video**
S-Video signal, such as a S-VHS VCR output signal, can be connected.
- **RGB Scart**
RGB Scart signal can be connected.

◆ Simple Computer System Setting

The projector has the Multi-scan system to conform to almost all computer output signals quickly. (See page 25.)

◆ Digital Zoom (for Computer)

The digital zoom function expands (to approx. 16 times of screen size) or compress the image size, allowing you to focus on crucial information at a presentation. (See page 31.)

◆ Interlace Progressive Conversion

High-quality picture is available with this technology which converts interlace signal into progressive signal. (See page 36.)

◆ Keystone Adjustment

Keystone distortion can be corrected not only vertically but also horizontally. The keystone correction function enables you to use the projector where you wish to use. (See page 20 and 38.)

◆ Power Management

The Power management function reduces power consumption and maintain the lamp life. (See page 39.)

◆ User's Logo

A projected image can be captured and used for the starting display of the projector with the Capture function. You can also display the captured image in an interval during your presentation instead of blackout image with the No show function. (See page 21, 38.)

◆ Lamp Mode

Brightness of the projection lamp can be changed by setting. The projector has the function to adjust the brightness according to an input signal for the best suited image. (See page 40.)

◆ Pointer Function

The projector has a convenient function which displays Spotlight or Pointer controlled by the remote control on a projected image. The remote control also has the Laser pointer function. These functions will make your important presentation more effective. (See page 13, 40.)

◆ Multilanguage Menu Display

Operation menu is available in; English, German, French, Italian, Spanish, Portuguese, Dutch, Swedish, Russian, Chinese, Korean, or Japanese. (See page 38.)

◆ Switchable Interface Terminal

The projector provides a switchable interface terminal. You can use the terminal as computer input or monitor output conveniently. (See page 39.)

◆ Digital Visual Interface

The projector is equipped with DVI 29-pin terminal for connecting DVI output from a computer or video equipment. You can also enjoy digital entertainment content protected by HDCP technology. (See page 24 for HDCP.)

◆ Wireless Mouse

The remote control supplied with this projector has wireless mouse function for a connected computer. This function enables you to operate both the projector and the connected computer with the remote control. (See page 14.)

Part Names and Functions

Front

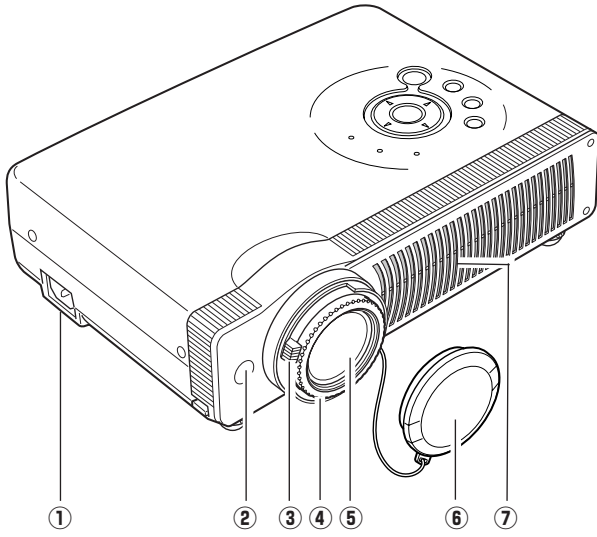

- ① Power Cord Connector
- ② Infrared Remote Receiver
- ③ Zoom Lever
- ④ Focus Ring
- ⑤ Projection Lens
- ⑥ Lens Cover (See page 54 for attaching.)
- ⑦ Air Intake Vent

Back

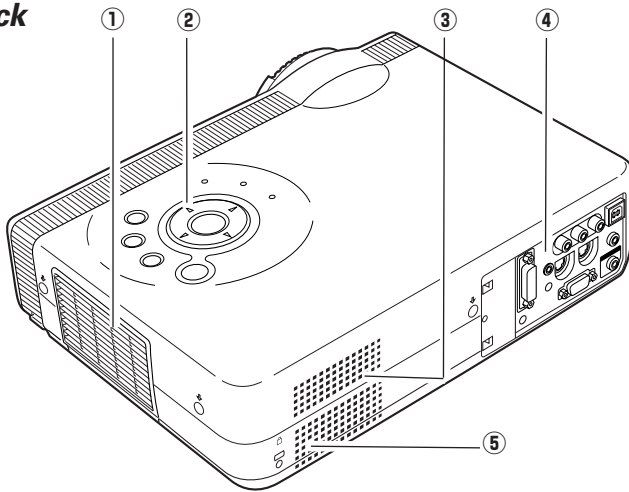

- ① Exhaust Vent



CAUTION

Hot air is exhausted from the exhaust vent. Do not put heat-sensitive objects near this side.

- ② Top Controls and Indicators
- ③ Air Intake Vent
- ④ Terminals and Connectors
- ⑤ Speaker

Bottom

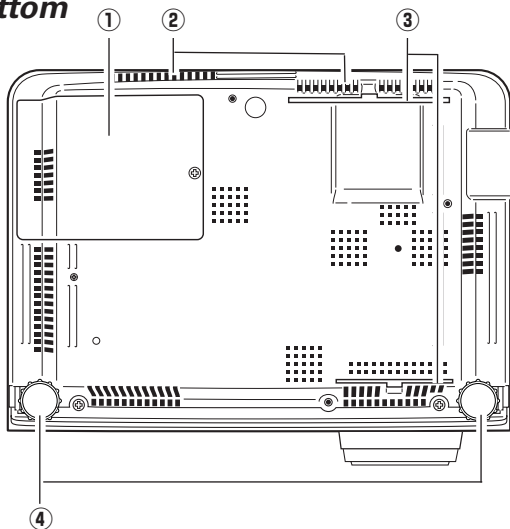

- ① Lamp Cover
- ② Air Intake Vent (back and bottom)
- ③ Air Filter
- ④ Adjustable Feet

Terminal

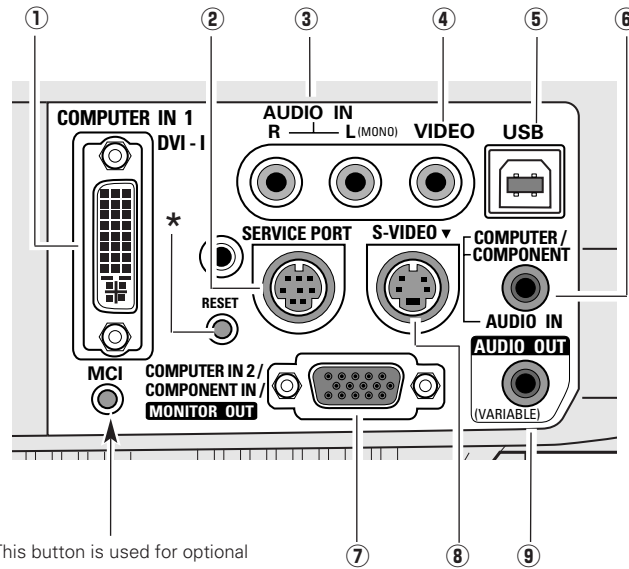

Do not press this button. This button is used for optional accessories.

① COMPUTER IN 1 DVI-I

Connect computer output (Digital/Analog DVI-I type) to this terminal. (p17)

② SERVICE PORT

This jack is used to service this projector.

③ AUDIO IN

Connect the audio output from video equipment connected to ④ or ⑧ to this jack. (When the audio output is monaural, connect it to L (MONO) jack.) (p17, 18)

④ VIDEO

Connect the composite video output from video equipment to VIDEO jack. (p18)

⑤ USB (Series B)

When operating the connected computer with the remote control, connect USB port of your computer to this connector with a USB cable. (p17)

⑥ AUDIO IN COMPUTER / COMPONENT

Connect the audio output (stereo) from a computer or video equipment connected to ① or ⑦ to this jack. (p17, 18)

⑦ COMPUTER IN 2 / COMPONENT IN / MONITOR OUT

This terminal is switchable and can be used as computer input, component input, RGB Scart 21-Pin Video input, or monitor output. Set the terminal up as either Computer input or Monitor output properly before using this terminal. An optional cable is required when using this terminal as component input or RGB Scart 21-Pin Video input. (p17, 18)

(This terminal outputs analog signal from COMPUTER IN 1 DVI-I terminal only when using as Monitor out.)

⑧ S-VIDEO

Connect the S-VIDEO output from video equipment to this jack. (p18)

⑨ AUDIO OUT (VARIABLE)

Connect an external audio amplifier to this jack. (p17, 18)

This terminal outputs sound from AUDIO IN terminal (③ or ⑥).

* A built-in micro processor which controls this unit may occasionally malfunction and need to be reset. This can be done by pressing the RESET button with a pen, which will shut down and restart the unit. Do not use the RESET function excessively.

Top

This projector has control buttons and indicators on its top.

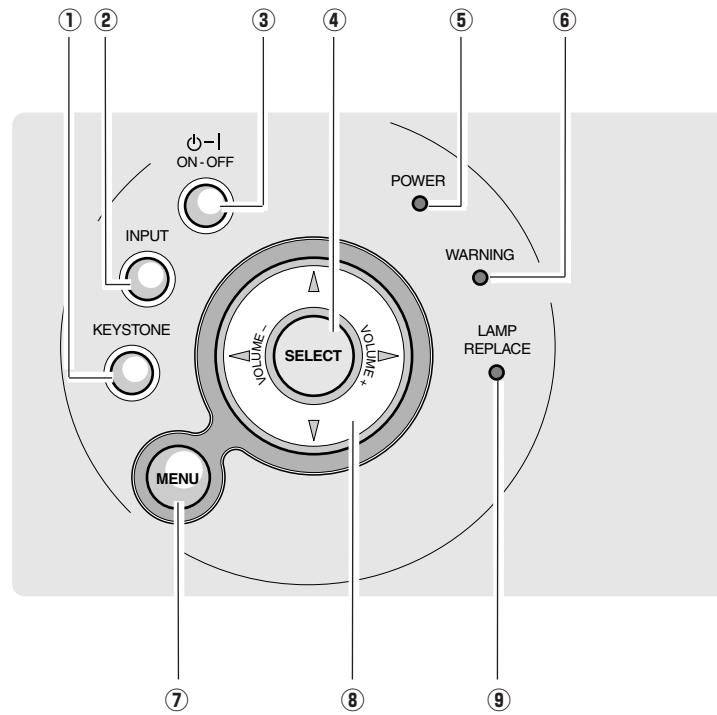

- ① **KEYSTONE button**
Corrects keystone distortion. (p20, 38)
- ② **INPUT button**
Selects input source. (p24, 32)
- ③ **POWER ON-OFF button**
Turns the projector on or off. (p19)
- ④ **SELECT button**
Executes the item selected. It is also used to expand / compress the image in Digital zoom +/- mode. (p31)
- ⑤ **POWER indicator**
Flashes red until the projector gets ready to be turned on. It turns red when the projector is in the stand-by mode. It remains green while the projector is under operation.
- ⑥ **WARNING indicator**
Lights red when the projector detects abnormal condition. This also flashes red when the internal temperature of the projector exceeds the operating range. (p41)
- ⑦ **MENU button**
Opens or closes the On-Screen Menu. (p22)
- ⑧ **POINT (Up/Down/Left/Right) button**
Selects an item or adjusts value in the On-Screen Menu. These are also used to pan the image in the Digital zoom +/- mode. (p31)
Point Left/Right button are used as VOLUME +/- button. (p21)
- ⑨ **LAMP REPLACE indicator**
Turns yellow when the life of the projection lamp draws to an end. (p43)

Remote Control

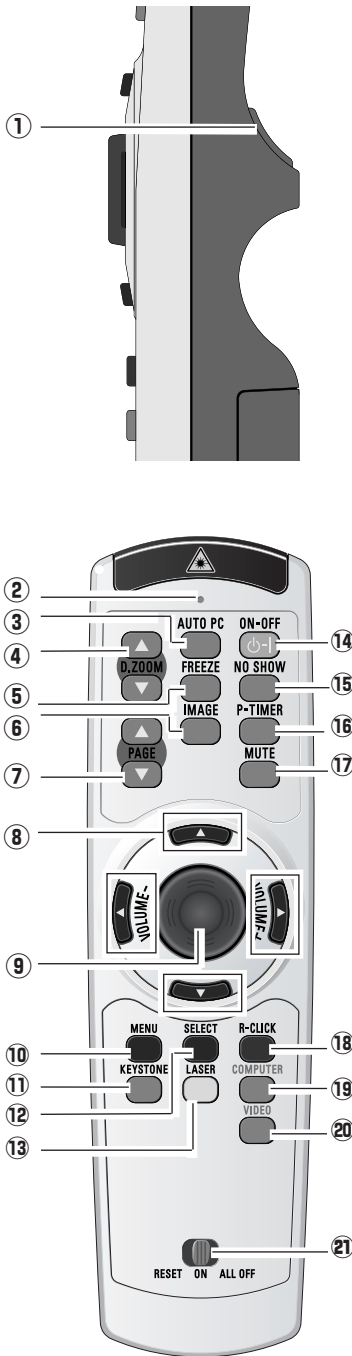

- ① **L-CLICK button**
Acts as left click for wireless mouse operation. (p14)
- ② **SIGNAL EMISSION indicator**
This indicator lights red while the laser beam is being emitted from the laser light window or a signal is being sent from the remote control to the projector.
- ③ **AUTO PC button**
Operates the Auto PC adjustment function. (p26)
- ④ **D.ZOOM button**
Selects the Digital zoom +/- mode and resize the image. (p31)
- ⑤ **FREEZE button**
Freezes the projected picture. (p20)
- ⑥ **IMAGE button**
Selects image levels.(p29, 35)
- ⑦ **PAGE UP/DOWN button**
Turns pages; the Up button to the previous page and the Down button to the next page for an image from a computer. Connect the projector and your computer with a USB cable before use. (p17)
- ⑧ **POINT (UP/DOWN/LEFT/RIGHT) button**
Selects an item or adjusts value in the On-Screen Menu. These are also used to pan the image in the Digital zoom +/- mode. (p31)
Point Left/Right button are also used as VOLUME +/- button. (p21)
- ⑨ **PRESENTATION POINTER button**
Move a pointer of the projector or a pointer for wireless mouse operation. (p13, 14)
- ⑩ **MENU button**
Opens or closes the On-Screen Menu. (p22)
- ⑪ **KEYSTONE button**
Corrects keystone distortion. (p20, 38)
- ⑫ **SELECT button**
Executes the item selected, or to expand or compress image in the Digital zoom +/- mode. (p31)
- ⑬ **LASER button**
Operates the Laser pointer function. Laser beam is emitted while pressing this button within 1 minute. When using this laser pointer for more than 1 minute, release the LASER button and press it again. This button is also used as a switching button to activate the Pointer function of the projector. (p13)
- ⑭ **POWER ON-OFF button**
Turns the projector on or off. (p19)
- ⑮ **NO SHOW button**
Turns the picture into black image. (p21)
- ⑯ **P-TIMER button**
Operates P-Timer function. (p21)
- ⑰ **MUTE button**
Mutes sound. (p21)
- ⑱ **R-CLICK button**
Acts as right click for wireless mouse operation. (p14)
- ⑲ **COMPUTER button**
Selects input source (COMPUTER 1 or COMPUTER 2). (p24)
- ⑳ **VIDEO button**
Selects input source (VIDEO). (p32)
- ㉑ **RESET/ON/ALL-OFF switch**
When using the remote control, set this switch to "ON." Set it to "ALL OFF" for energy saving when it is not used. Slide this switch to the "RESET" to initialize the remote control code. (p14)

Laser Pointer Function

This remote control emits a laser beam as Laser pointer function from the laser light window. When the LASER button is pressed, laser light goes on. When the LASER button is being pressed for more than 1 minute or the LASER button is released, light goes off. The signal emission indicator lights red and laser is emitted with red light to indicate laser beam is being emitted.

The laser emitted is a class II laser; therefore, do not look into the laser light window or shine the laser beam on yourself or other people. The marks below are caution labels for laser beam.

CAUTION : Use of controls, adjustments or performance of procedures other than those specified herein may result in hazardous radiation exposure. Do not look into the laser light window while laser is emitting, otherwise eye damage may result.

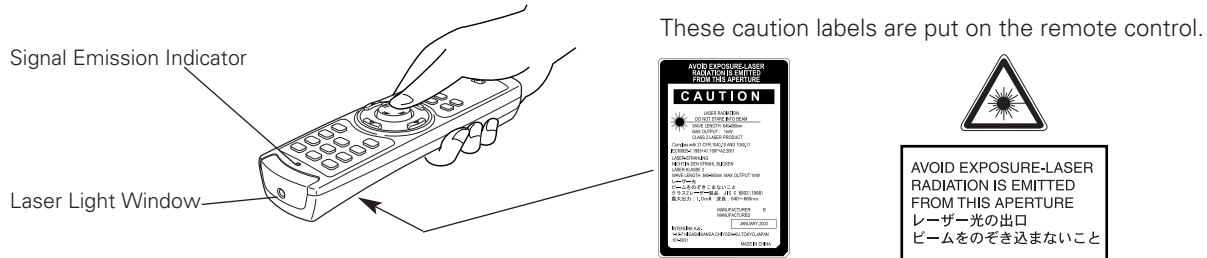

Pointer Function

You can move Spotlight or Pointer of the projector with the remote control to emphasize a part of the projected image. (See "Pointer" on page 40 for changing the patterns and sizes.)

- 1 While pressing the MENU button, hold down the NO SHOW button for more than 7 seconds so that the Pointer function can be available. (The Laser pointer function has switched to the Pointer function.)
- 2 Press the LASER button on the remote control toward the projector and see if the LASER button lights green, and Spotlight or Pointer is displayed on the screen. Then you can move Spotlight or Pointer with the PRESENTATION POINTER button. If the LASER button does not light green and still emits laser beam, the Laser pointer function has not switched to the Pointer function yet. Try these steps until the LASER button lights green.
- 3 To clear Spotlight or Pointer displayed on the screen, press the LASER button toward the projector and see if the LASER button turns off.
To use the Laser pointer function once again, while pressing the MENU button, hold down the NO SHOW button for more than 7 seconds.

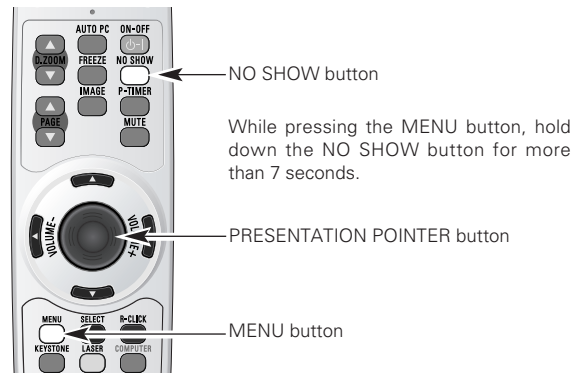

Spotlight

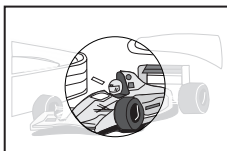

Pointer

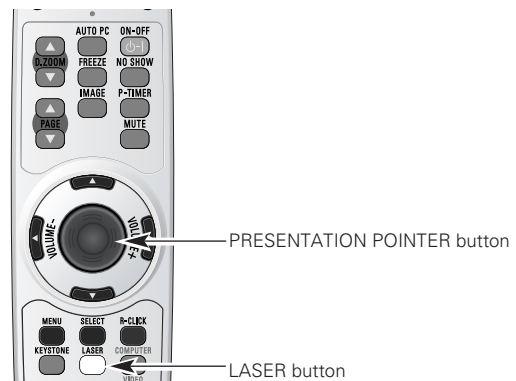
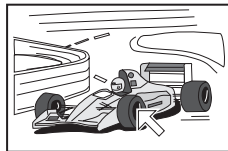

NOTE

- You can choose the size of Spotlight (Large, Middle, and Small) and the pattern of Pointer (Arrow, Finger, and Dot) in the Setting Menu. See "Pointer" on page 40.

After the Laser pointer function has switched to the Pointer function, the LASER button is used as the Pointer function ON-OFF switch instead of the Laser pointer function.
Press the LASER button toward the projector and see if it lights green.

Remote Control Code

This projector has eight different remote control codes (Code 1-Code 8); the factory-set, initial code (Code 1) and the other seven codes (Code 2 to Code 8). This switching function prevents remote control interference when operating several projectors or video equipment at the same time. (Change the remote control code for the projector first before changing that for the remote control. See "Remote control" on page 40.)

- 1 While pressing the MENU button, press the IMAGE button number of times corresponding to each remote control code number. Each time you press the IMAGE button, the code is changed sequentially. (See the list below.)
- 2 To initialize the remote control code for the remote control, slide the RESET/ON/ALL-OFF switch to the RESET, and then to the ON. The initial code is Code 1.

Remote Control Code	Number of Times of Pressing IMAGE Button
Code 1	1
Code 2	2
Code 3	3
Code 4	4
Code 5	5
Code 6	6
Code 7	7
Code 8	8

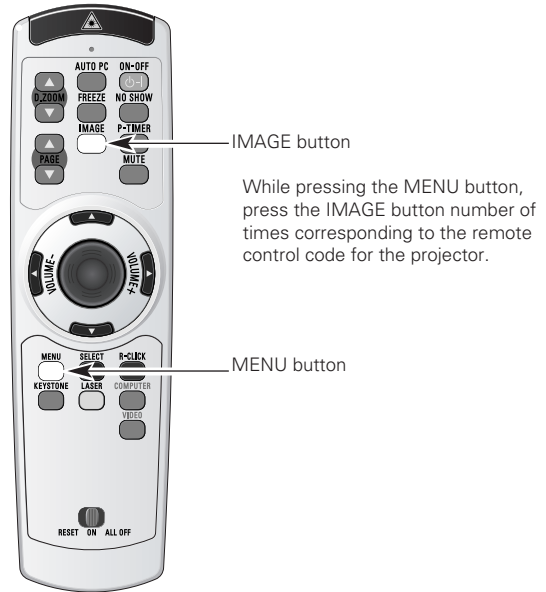

Wireless Mouse Operation

The remote control can be used as a wireless mouse for your computer. Before operating the wireless mouse, connect your computer and the projector with the supplied USB cable. (See page 17 for connection.) When the Pointer function is used, the wireless mouse is not available.



Remote Control Operating Range

Point the remote control toward the projector (Infrared Remote Receiver) whenever pressing any button. Maximum operating range for the remote control is about 16.4' (5m) and 60° in front of the projector.

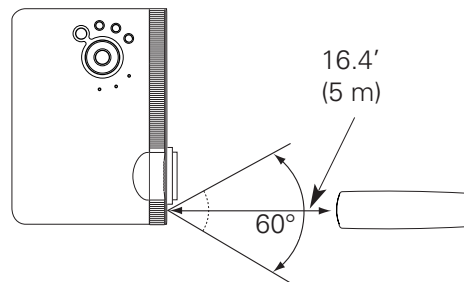

Remote Control Batteries Installation

- 1** Remove the battery compartment lid.

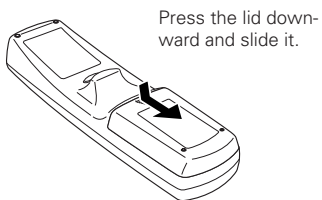

- 2** Slide the batteries into the compartment.

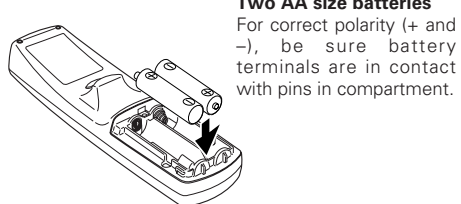

- 3** Replace the compartment lid.

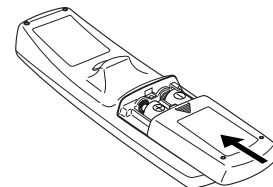

To insure safe operation, please observe the following precautions :

- Use (2) AA, UM3 or R06 type alkaline batteries.
- Replace two batteries at the same time.
- Do not use a new battery with a used battery.
- Avoid contact with water or liquid.
- Do not expose the remote control to moisture, or heat.
- Do not drop the remote control.
- If a battery has leaked on remote control, carefully wipe case clean and install new batteries.
- Risk of explosion if battery is replaced by an incorrect type.
- Dispose of used batteries according to the instructions.

Installation

Positioning the Projector

This projector is designed to project on a flat projection surface and can be focused from 3.3'(1.0m) - 25.3'(7.7m). Refer to the figure and the table below for the screen size and the distance between the projector and the screen.

A : B = 9 : 1

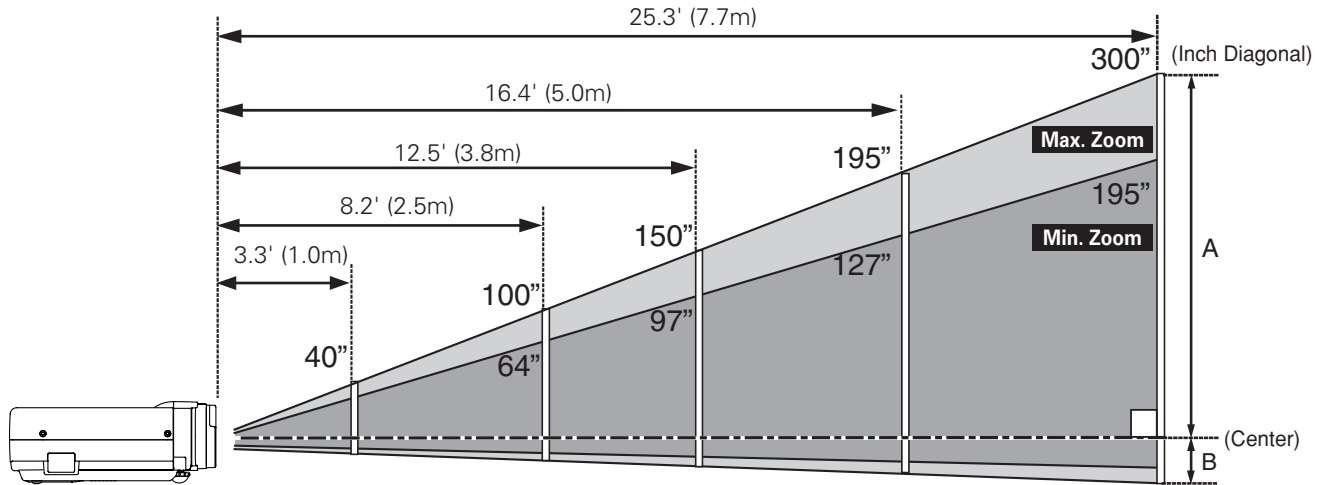

Screen Size (W x H) mm	40"	100"	150"	195"	300"
4 : 3 aspect ratio	813 x 610	2032 x 1524	3048 x 2286	3962 x 2972	6096 x 4572
Zoom (min)	4.9' (1.5m)	12.8' (3.9m)	19.3' (5.9m)	25.3' (7.7m)	—
Zoom (max)	3.3' (1.0m)	8.2' (2.5m)	12.5' (3.8m)	16.4' (5.0m)	25.3' (7.7m)

NOTE

- The brightness in a room has a great influence on picture quality. It is recommended to limit ambient lighting in order to provide the best image.
- The values shown are approximate and may vary from the actual size.

Adjustable Feet

Projection angle can be adjusted up to 11.8 degrees with the adjustable feet.

- 1 Lift the front of the projector and pull the foot lock latches on both sides of the projector.
- 2 Release the foot lock latches to lock the adjustable feet and rotate the adjustable feet to adjust the position and tilt.
- 3 To retract the adjustable feet, lift the front of the projector and pull and undo the foot lock latches.
Keystone distortion of the projected image can be adjusted by menu operation. (p20, 38)



CAUTION

Tilt the projector within the adjustable range in order not to shorten the life of the lamp. Proper angle should be taken. See page 5.

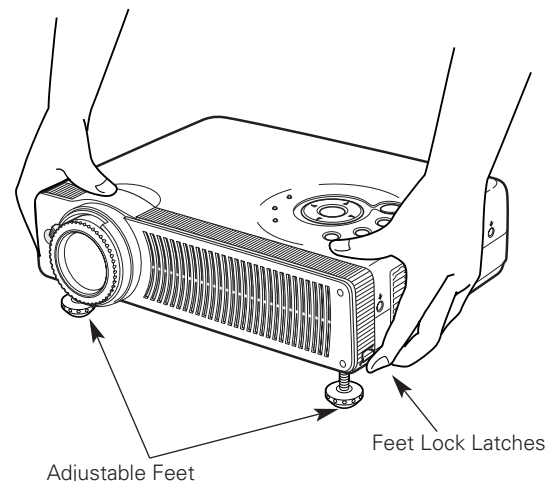

Connecting to a Computer

Cables used for connection (* = These accessories are not supplied with this projector.)

- VGA Cable (HDB 15 pin) *
- DVI-VGA Cable (HDB 15 pin)
- DVI-Digital Cable (for Single Link T.M.D.S.) *
- USB Cable
- MAC Adapter (When connecting to Macintosh computer) *
- Audio Cables (Mini Plug (stereo) x 2) *

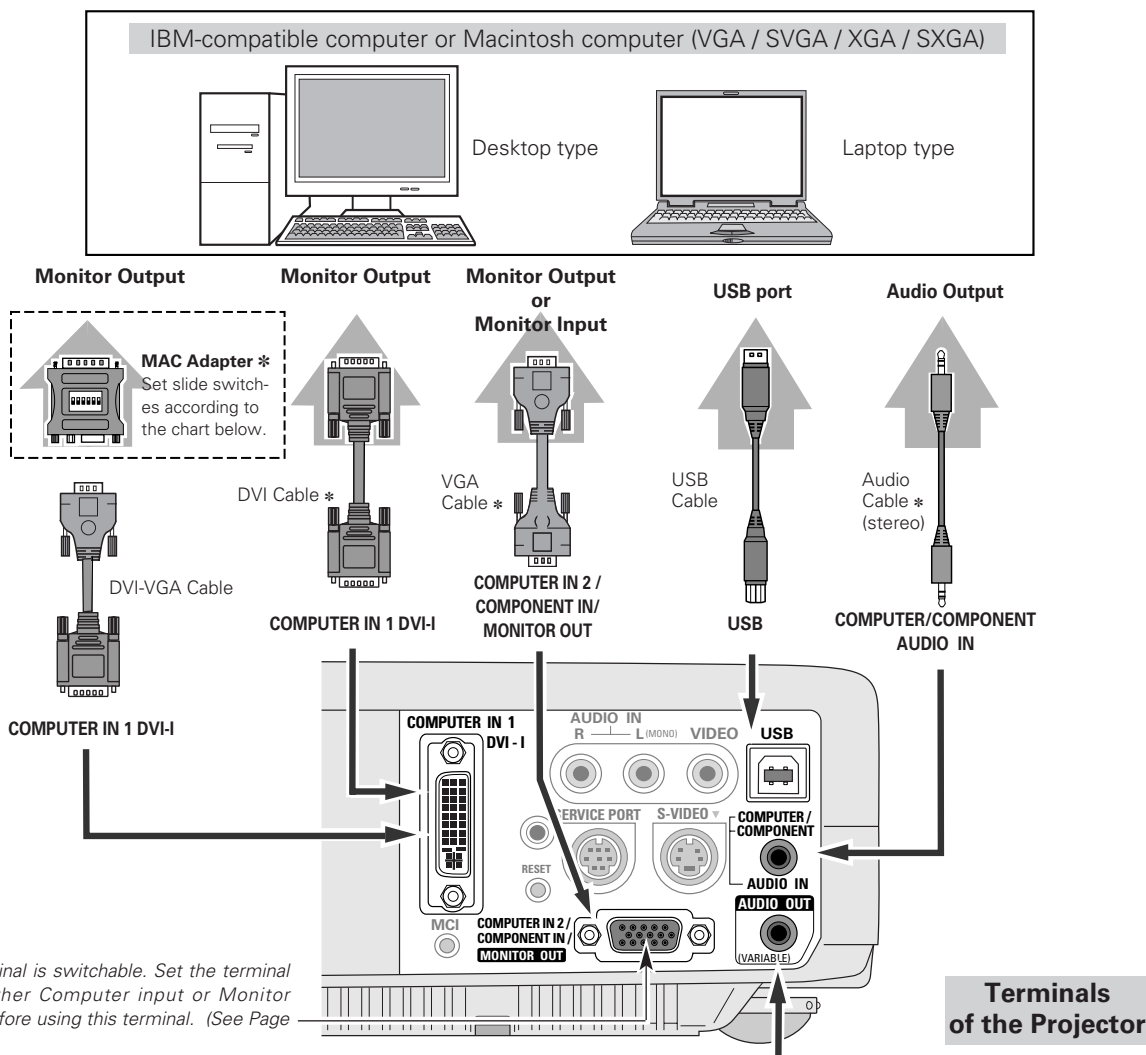

NOTE :
When connecting the cable, the power cords of both the projector and the external equipment should be disconnected from AC outlet.

◆ **MAC ADAPTER (Not supplied)**
Set switches as shown in the table below depending on RESOLUTION MODE that you want to use before you turn on projector and computer.

	1	2	3	4	5	6
13" MODE (640 x 480)	ON	ON	OFF	OFF	OFF	OFF
16" MODE (832 x 624)	OFF	ON	OFF	ON	OFF	OFF
19" MODE (1024 x 768)	OFF	ON	ON	OFF	OFF	OFF
21" MODE (1152 x 870)	ON	ON	ON	ON	OFF	OFF

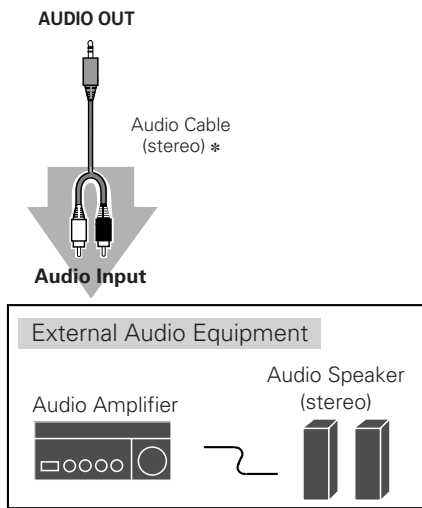

Connecting to Video Equipment

Cables used for connection (* = These accessories are not supplied with this projector.)

- Video Cable (RCA x 1) *
- S-VIDEO Cable *
- Audio Cables (Mini Plug (stereo) x 2 or RCA x 2) *
- Scart-VGA Cable *
- Component-VGA Cable *
- Component-VGA Cable *

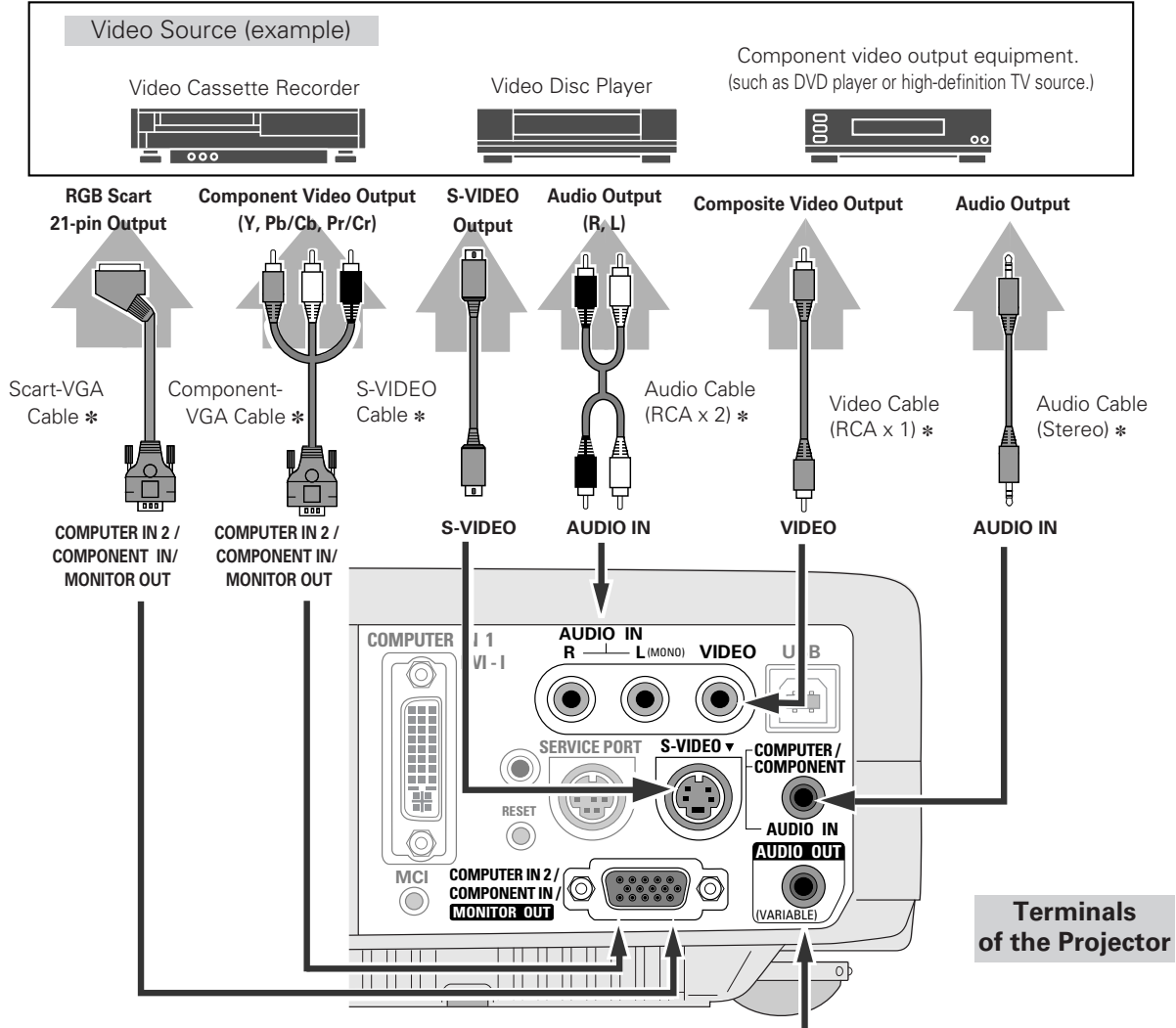

NOTE

- The S-VIDEO jack has priority over the VIDEO jack under the condition of connecting both the S-VIDEO jack and the VIDEO jack when selecting AUTO in the Input Menu.
- Select COMPUTER 2 in the Setting Menu when the COMPUTER IN 2/COMPONENT IN/MONITOR OUT terminal is used as RGB Scart 21-Pin video input or Component video input. (See "Terminal" on page 39.)
- Input sound to the COMPUTER/COMPONENT AUDIO IN terminal when using the COMPUTER IN 2/COMPONENT IN/MONITOR OUT terminal as input.



NOTE :
When connecting the cable, the power cords of both the projector and the external equipment should be disconnected from AC outlet.

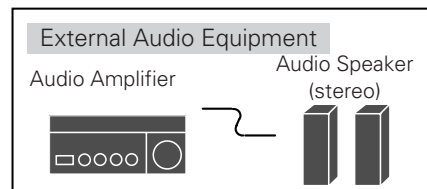

Basic Operation

Turning On the Projector

- 1 Complete peripheral connections (with a computer, VCR, etc.) before turning on the projector.
- 2 Connect the projector's AC power cord into an AC outlet. The POWER indicator flashes red in a moment and turns on red.
- 3 Press the POWER ON-OFF button on the top control or on the remote control. The POWER indicator turns green, and the cooling fans start to operate. The preparation display appears on the screen and the count down starts. (A captured image can be used as the preparation display. See "Capture" on page 38.)
- 4 After the count-down, the input source that was selected last and the Lamp mode status icon appear on the screen.

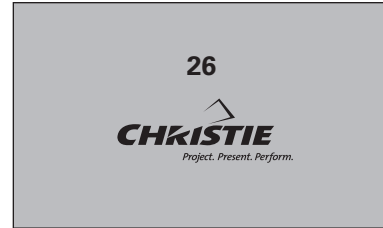

The preparation display disappears after 30 seconds.

Selected Input Source and Lamp Mode

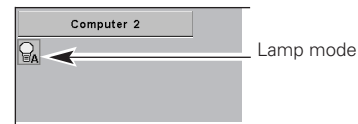

(See page 40 for Lamp mode.)

Turning Off the Projector

- 1 Press the POWER ON-OFF button on the top control or on the remote control, and a message "Power off?" appears on the screen.
- 2 Press the POWER ON-OFF button again to turn off the projector. The POWER indicator starts to flash red, and it continues while the cooling fans are operating (for about 90 seconds).
- 3 When the projector has cooled down enough to be turned on again, the POWER indicator lights red. Then you can disconnect the AC power cord.

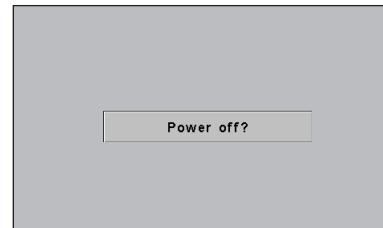

The message disappears after 4 seconds.



TO MAINTAIN THE LIFE OF LAMP, ONCE YOU TURN PROJECTOR ON, WAIT AT LEAST 5 MINUTES BEFORE TURNING IT OFF.
DO NOT DISCONNECT AC POWER CORD WHILE COOLING FANS ARE RUNNING OR BEFORE POWER INDICATOR LIGHTS RED. OTHERWISE IT WILL RESULT IN SHORTENING LAMP LIFE.

NOTE

- The projector cannot be turned on during the cooling period with the POWER indicator flashing red. You can turn it on again after the POWER indicator lights red.
- When the On start function is on, this projector is turned on automatically by connecting the AC power cord to an AC outlet. (See page 39 for the On start function.)
- This projector monitors internal temperature and automatically controls the running speed of the cooling fans.
- If the WARNING indicator flashes or lights red, see "Warning Indicator" on page 41.

Zoom Adjustment

Move the Zoom Lever to zoom in and out.

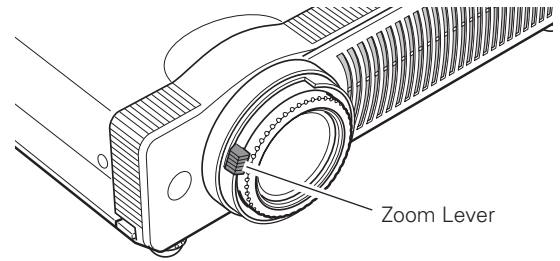

Focus Adjustment

Rotate the Focus Ring to adjust the projected picture focus.

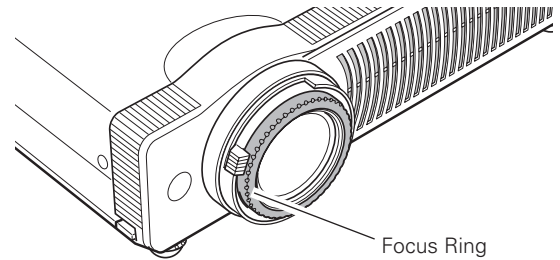

Keystone Adjustment

If a projected picture has keystone distortion, correct the image with KEYSTONE adjustment.

- 1 Press the KEYSTONE button on the remote control or select Keystone in the Setting Menu (p38). The keystone dialog box appears.
- 2 Correct keystone distortion by pressing the Point Up/Down/Left/Right button. Press the Point Up button to reduce the upper part of the image, and press the Point Down button to reduce the lower part. Press the Point Left button to reduce the left part, and press the Point Right button to reduce the right part. Keystone adjustment can be memorized. (p38)



- The arrows are white when there is no correction.
- The arrows disappear at the maximum correction.
- The direction of the arrow being corrected turns red.
- If you press the KEYSTONE button on the top control or on the remote control once more while the keystone dialog box is being displayed, the keystone adjustment will be canceled.

Reduce the upper width with Point Up button.

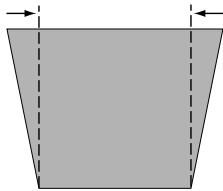

Reduce the lower width with Point Down button.

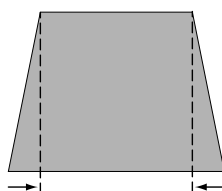

Reduce the left part with Point Left button.

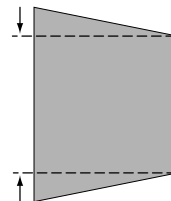

Reduce the right part with Point Right button.

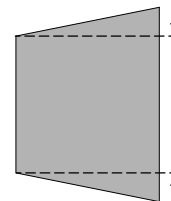

Picture Freeze Function

Press the FREEZE button on the remote control to freeze the picture on the screen. To cancel the FREEZE function, press the FREEZE button again or press any other button.

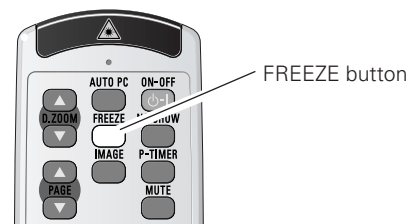

No Show Function

Press the NO SHOW button on the remote control to black out the image. To restore to normal, press the NO SHOW button again or press any other button. When a projected image is captured and set as "User" in the Logo item in the Setting Menu (p38), the screen changes each time you press the NO SHOW button as follows.

black out → the captured image → normal →

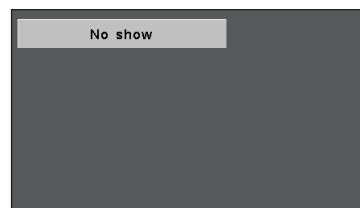

The message disappears after 4 seconds.

P-Timer Function

Press the P-TIMER button on the remote control. The timer display "00 : 00" appears on the screen and the timer starts to count time (00 : 00 ~ 59 : 59).

To stop the P-Timer, press the P-TIMER button. And then, press the P-TIMER button again to cancel the P-Timer function.



Sound Adjustment

Direct Operation

Volume

Press the VOLUME (+/-) button on the top control or on the remote control to adjust volume. The volume dialog box appears on the screen for a few seconds.

(+) button to turn up the volume and (-) button to turn down the volume.

Mute

Press the MUTE button on the remote control to cut off sound. To restore sound to its previous level, press the MUTE button again or press the VOLUME (+/-) button.

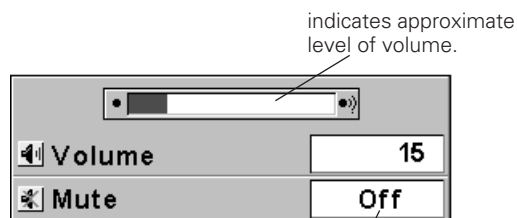

indicates approximate level of volume.

Press the MUTE button to set the Mute function On or Off.

The display disappears after 4 seconds.

Menu Operation

1 Press the MENU button and the On-Screen Menu will appear. Press the Point Left/Right button to move the red frame pointer to the Sound Menu icon.

2 Press the Point Down button to move the red frame pointer to the item that you want to select, and then press the SELECT button.

Volume

Press the Point Right button to turn up the volume, and press the Point Left button to turn down the volume.

Mute

Press the Point Left/Right button to cut off sound. Dialog box display is changed to "On" and sound is cut off. To restore sound to its previous level, press the Point Left/Right button again.

Sound Menu

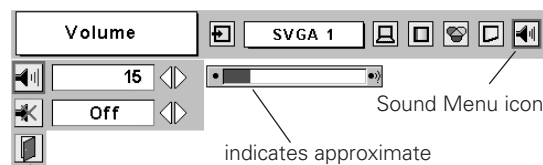

Sound Menu icon

indicates approximate level of volume.

closes the Sound Menu.

On-Screen Menu

You can control and adjust this projector through the On-Screen Menu. Refer to the following pages to operate each adjustment on the On-Screen Menu.

- 1 Press the MENU button to display the On-Screen Menu (Menu bar). A red frame is a pointer.
- 2 Move the pointer (red frame) to the Menu icon that you want to select by pressing the Point Left/Right button.
- 3 Press the Point Down button and move the pointer (red frame or red arrow) to the item that you want to adjust, and then press the SELECT button to show the item data.
- 4 Adjust the item data by pressing the Point Left/Right button. Refer to the following pages for details of respective adjustments.
- 5 To close this menu, select Quit. To clear the On-Screen Menu, press the MENU button on the top control or on the remote control.

Remote Control

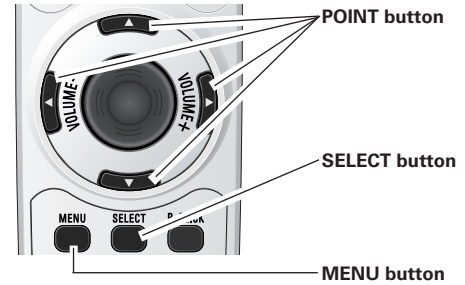

Top Control

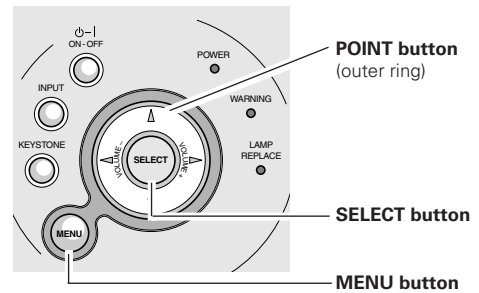

On-Screen Menu

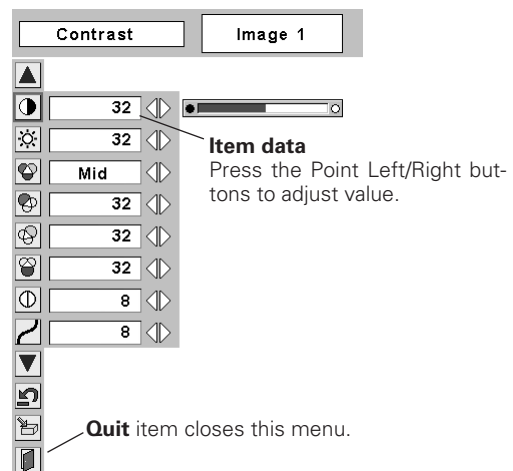
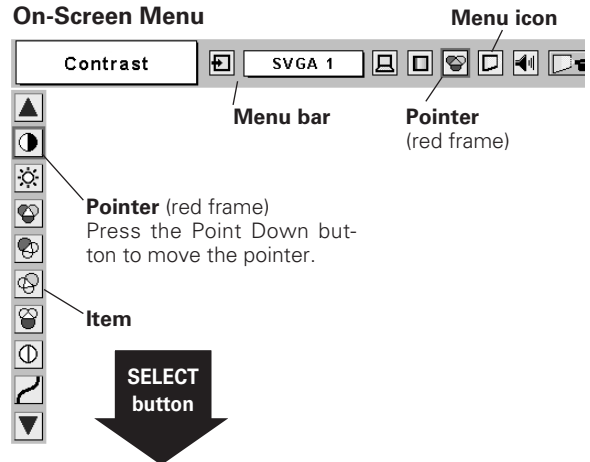

Menu Bar

For computer source

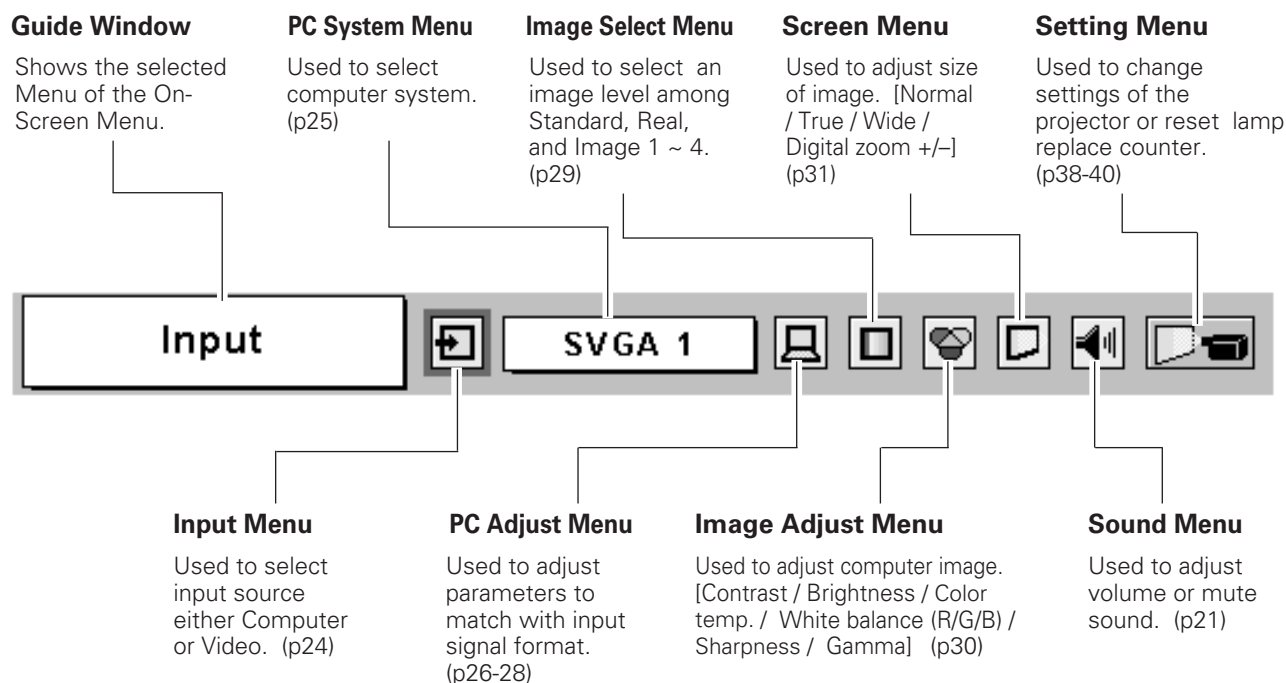

For video source

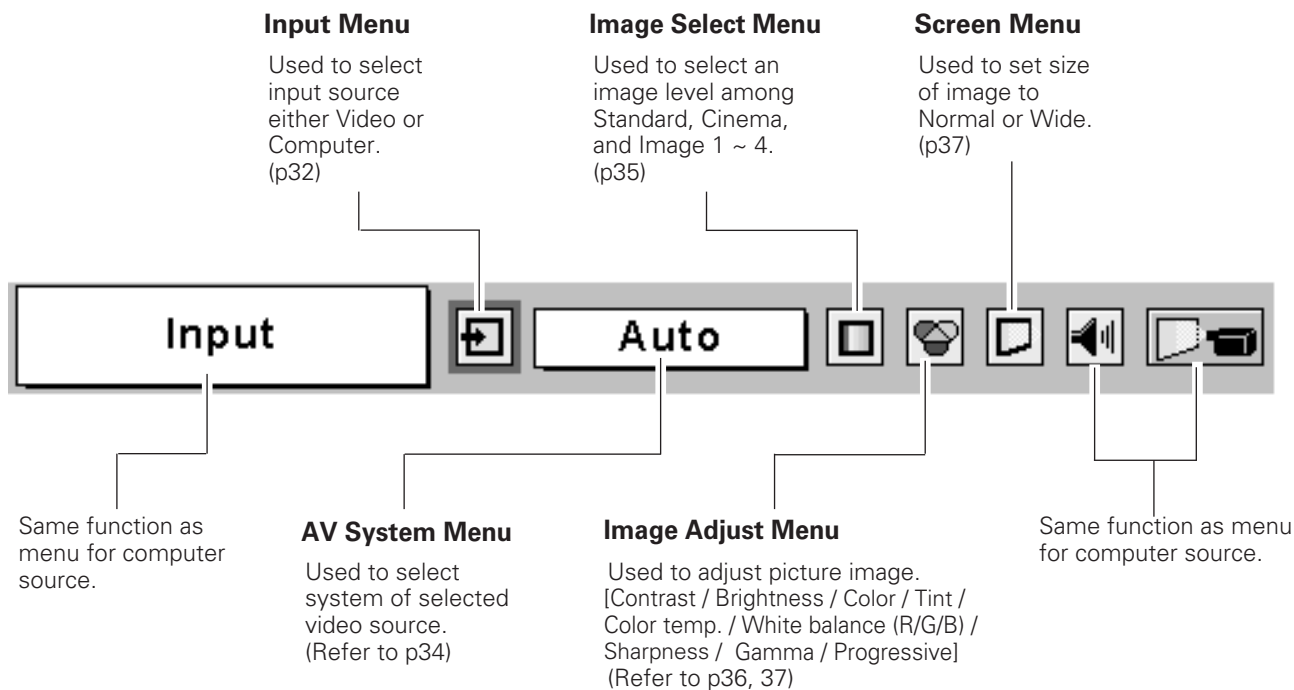

Computer Input

Input Source Selection

Direct Operation

Choose either Computer 1 or Computer 2 by pressing the INPUT button on the top control or press the COMPUTER button on the remote control.

Before using these buttons, correct input source should be selected through menu operation as described below.

Menu Operation

- 1 Press the MENU button and the On-Screen Menu will appear. Press the Point Left/Right button to move the red frame pointer to the Input Menu icon.
- 2 Press the Point Down button to move the red arrow pointer to either Computer 1 or Computer 2 (Only the Computer 1 is displayed when Monitor out is selected in the Setting Menu.), and then press the SELECT button. The Source Select Menu will appear.
- 3 Move the pointer to the correct input source and then press the SELECT button.

RGB (Analog) When the input source is analog coming from a computer through the DVI terminal, select RGB (Analog).

RGB (PC Digital) When the input source is digital coming from a computer through the DVI terminal, select RGB (PC Digital).

RGB (AV HDCP) When the input source compatible with HDCP is coming from video equipment through the DVI terminal, select RGB (AV HDCP).

RGB When the input source is analog coming from a computer through the COMPUTER IN 2/COMPONENT IN/MONITOR OUT terminal, select RGB.

NOTE

- *HDCP (High-bandwidth Digital Content Protection) is a system for protecting digital entertainment content delivered by DVI (Digital Visual Interface) from being copied. The specification of HDCP is decided and controlled by Digital Content Protection, LLC. Should the specification be changed, this projector may not display the digital content protected by HDCP.*

INPUT button

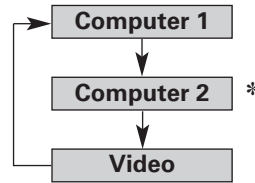

COMPUTER button

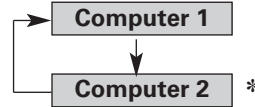

* Computer 2 is not displayed when the COMPUTER IN 2/COMPONENT IN/MONITOR OUT terminal is used as Monitor out.

Input Menu

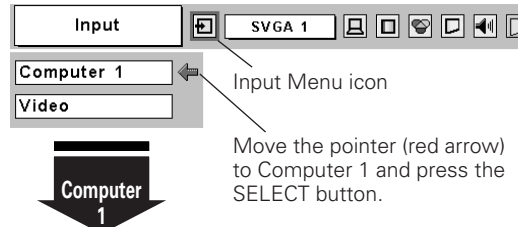

Source Select Menu

Move the pointer to RGB(Analog), RGB (PC Digital), or RGB(AV HDCP) and press the SELECT button.

* Computer 2 is not displayed when the COMPUTER IN 2/COMPONENT IN/MONITOR OUT terminal is used as Monitor out.

Input Menu

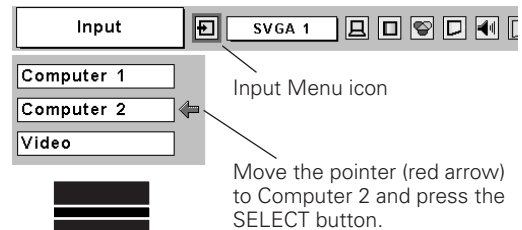

Source Select Menu

Move the pointer to RGB and press the SELECT button.

Computer System Selection

This projector can detect most of the current computer systems with the Multi-scan system and the Auto PC adjustment function provided in the projector. When selecting computer input, the projector automatically displays the most proper image for the input signal. One of the following four displays appears on the system menu icon. If the projector does not tune the input signal and the projected image is not displayed properly, or when you wish to adjust it manually, perform manual adjustment as described on page 27 and 28.

Auto

When the projector cannot recognize the connected signal as PC system provided in this projector, the Auto PC Adjustment function operates to adjust the projector and the message "Auto" is displayed in the PC System Menu icon. When the image is not provided properly, manual adjustment is required. (p26, 27)

There is no signal input from the connected computer. Check the connection of the computer and see if the projector is set correctly. (See "Troubleshooting" on page 45.)

Mode 1

User preset adjustment in Computer Adjustment. Adjustment data can be stored in Mode 1 - 5. (page 27, 28.)

SVGA 1

Computer systems provided in the projector. The projector chooses a proper system and displays it.

*Mode 1 and SVGA 1 are examples.

PC system can also be selected manually if some PC systems appear on the On-Screen Menu.

- 1 Press the MENU button and the On-Screen Menu will appear. Press the Point Left/Right buttons to move the red frame pointer to the PC System Menu icon.
- 2 Press the Point Down button to move the red arrow pointer to the system that you want to set, and then press the SELECT button.

PC System Menu

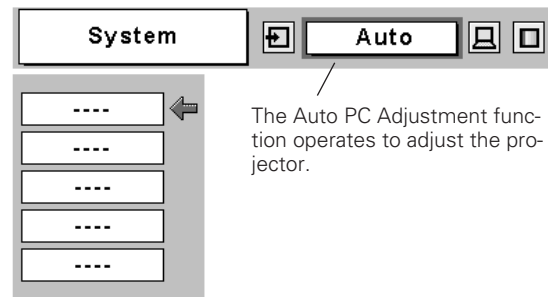

The Auto PC Adjustment function operates to adjust the projector.

PC System Menu

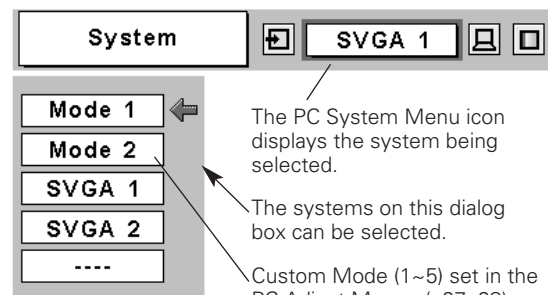

The PC System Menu icon displays the system being selected.

The systems on this dialog box can be selected.

Custom Mode (1~5) set in the PC Adjust Menu. (p27, 28)

Computer Adjustment (Auto)

Auto PC Adjustment function is provided to automatically adjust Fine sync, Total dots, Horizontal, and Vertical to conform to your computer. Auto PC Adjustment function can be operated as follows.

- 1 Press the MENU button and the On-Screen Menu will appear. Press the Point Left/Right button to move the red frame pointer to the PC Adjust Menu icon.
- 2 Press the Point Down button to move the red frame pointer to the Auto PC Adj. icon and then press the SELECT button twice. This Auto PC Adjust can also be executed by pressing the AUTO PC button on the remote control.

Auto PC Adj.

Automatically adjusts Fine sync, Total dots, Horizontal, and Vertical for the input signal from your computer.

To store adjustment data

Adjustment parameters from Auto PC Adjustment can be memorized in this projector. Once parameters are memorized, the setting can be done just by selecting Mode in the PC System Menu (p25). See "Store" on page 28.

NOTE

- The PC Adjust Menu cannot be operated when the input signal is digital or a signal compatible with HDCP.
- The Auto PC Adjust cannot be operated when 480i, 575i, 480p, 575p, 720p, 1035i, or 1080i is selected in the PC System Menu.

PC Adjust Menu

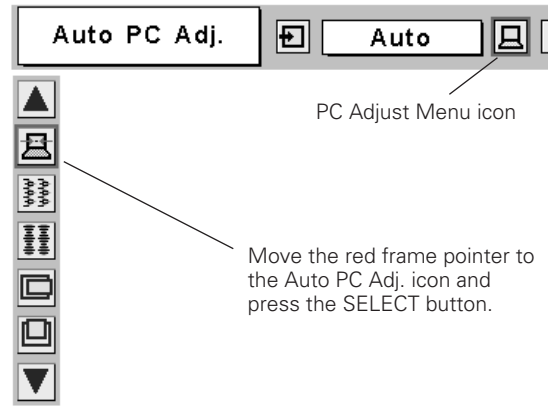

Computer Adjustment (Manual)

Some computers employ special signal formats which may not be tuned by Multi-scan system of this projector. This projector has Manual PC Adjustment to enable you to precisely adjust several parameters to match those signal formats. The projector has 5 independent memory areas to memorize those parameters manually adjusted. This enables you to recall the setting for a specific computer whenever you use it.

- 1 Press the MENU button and the On-Screen Menu will appear. Press the Point Left/Right button to move the red frame pointer to the PC Adjust Menu icon.
- 2 Press the Point Down button to move the red frame pointer to the item that you want to adjust and then press the SELECT button. An adjustment dialog box will appear. Press the Point Left/Right button to adjust value.

Fine sync

Adjusts an image as necessary to eliminate flicker from the display. Press the Point Left/Right button to adjust value. (From 0 to 31)

Total dots

Adjusts the number of total dots in one horizontal period. Press the Point Left/Right button and adjust number to match your PC image.

Horizontal

Adjusts horizontal picture position. Press the Point Left/Right button to adjust the position.

Vertical

Adjusts vertical picture position. Press the Point Left/Right button to adjust the position.

Current mode

Press the SELECT button to show the information of the connected computer.

Clamp

Adjusts clamp level. When the image has dark bars, try this adjustment.

PC Adjust Menu



PC Adjust Menu icon

Move the red frame pointer to an item and press the SELECT button.



Shows status (Stored / Free) of the selected Mode.



Press the Point Left/Right button to adjust the value.



Press the SELECT button at this icon to display other items.

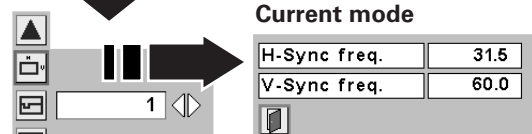

Press the SELECT button at the Current mode icon to show the information of the connected computer.



Press the SELECT button at this icon to jump to the top item.

Display area

Select the resolution at the Display area dialog box.

Display area H

Adjusts the horizontal area displayed by this projector. Press the Point Left/Right button to decrease/increase value and then press the SELECT button.

Display area V

Adjusts the vertical area displayed by this projector. Press the Point Left/Right button to decrease/increase value and then press the SELECT button.

Full screen

When this function is on, SXGA image is fully displayed at 4 : 3 aspect ratio. It is displayed at 5 : 4 aspect ratio with this function off.

Reset

Resets all adjustment to their previous levels.

Store

To store adjustment data, move the red frame pointer to the Store icon and then press the SELECT button. Move the red arrow pointer to any of Mode 1 to 5 in which you want to store and then press the SELECT button.

Mode free

To clear adjustment data previously set, move the red frame pointer to the Mode free icon and then press the SELECT button. Move the red arrow pointer to the Mode that you want to clear and then press the SELECT button.

Quit

Closes the PC Adjust Menu.

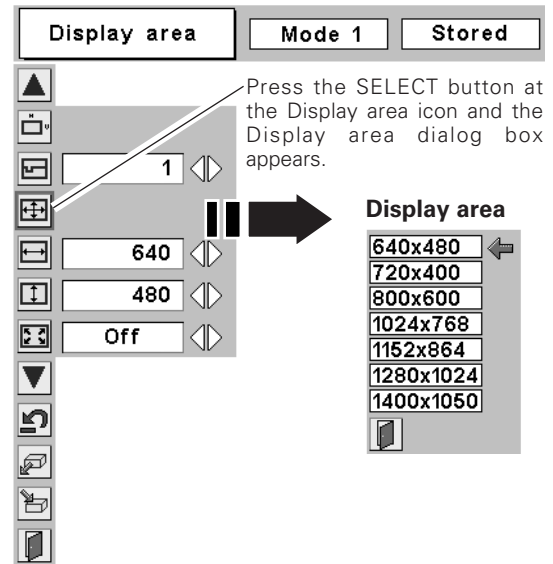

Press the SELECT button at the Display area icon and the Display area dialog box appears.

To store adjustment data

This Mode has parameters being stored.

Where to reserve ?						
Mode	Status	Total dots	Horizontal	Vertical	Display area H	Display area V
Mode 1	Stored	800	142	34	640	480
Mode 2	Free	800	143	34	640	480
Mode 3	Free	800	143	34	640	480
Mode 4	Free	800	143	34	640	480
Mode 5	Free	800	143	34	640	480

Vacant Mode

shows values of "Total dots," "Horizontal," "Vertical," "Display area H," and "Display area V."

To clear adjustment data

Which mode to free ?						
Mode	Status	Total dots	Horizontal	Vertical	Display area H	Display area V
Mode 1	Stored	800	142	34	640	480
Mode 2	Free	800	143	34	640	480
Mode 3	Free	800	143	34	640	480
Mode 4	Free	800	143	34	640	480
Mode 5	Free	800	143	34	640	480

closes this dialog box.

NOTE

- Auto PC Adjust, Display area, Display area (H/V), and Full screen cannot be selected when "480i", "575i", "480p", "575p", "720p", "1035i", or "1080i" is selected in the PC System Menu (p25).

Image Level Selection

Direct Operation

Select an image level among Standard, Real, Image 1, Image 2, Image 3, and Image 4 by pressing the IMAGE button on the remote control.

Standard

Normal picture level preset on this projector.

Real

Picture level with improved halftone for graphics.

IMAGE 1~4

User preset image in the Image Adjust Menu (p30).

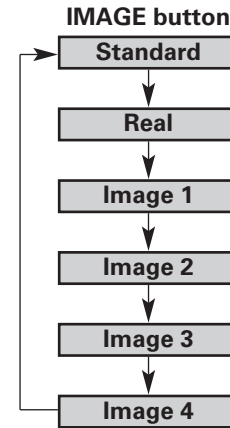

Menu Operation

- 1 Press the MENU button and the On-Screen Menu will appear. Press the Point Left/Right button to move the red frame pointer to the Image Select Menu icon.
- 2 Press the Point Down button to move the red frame pointer to the level that you want to set and then press the SELECT button.

Standard

Normal picture level preset on this projector.

Real

Picture level with improved halftone for graphics.

IMAGE 1~4

User preset image in the Image Adjust Menu (p30).

Image Select Menu

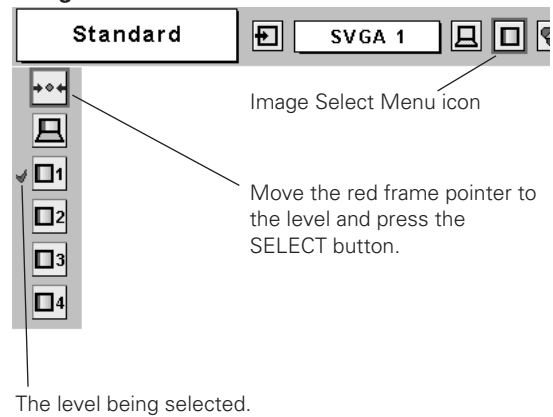

Image Level Adjustment

- 1 Press the MENU button and the On-Screen Menu will appear. Press the Point Left/Right button to move the red frame pointer to the Image Adjust Menu icon.
- 2 Press the Point Down button to move the red frame pointer to the item that you want to adjust, and then press the SELECT button. The level of each item is displayed. Adjust each level by pressing the Point Left/Right button.

Contrast

Press the Point Left button to decrease contrast and the Point Right button to increase contrast. (From 0 to 63.)

Brightness

Press the Point Left button to adjust image darker and the Point Right button to adjust image brighter. (From 0 to 63.)

Color temp.

Press the Point Left button or the Point Right button for Color temp. level that you want to select. (XLow, Low, Mid, or High)

White balance (Red)

Press the Point Left button to lighten red tone and the Point Right button to deepen red tone. (From 0 to 63.)

White balance (Green)

Press the Point Left button to lighten green tone and the Point Right button to deepen green tone. (From 0 to 63.)

White balance (Blue)

Press the Point Left button to lighten blue tone and the Point Right button to deepen blue tone. (From 0 to 63.)

Sharpness

Press the Point Left button to soften the image and the Point Right button to sharpen the image. (From 0 to 15.)

Gamma

Press the Point Left/Right button to obtain better balance of contrast. (From 0 to 15.)

Reset

Resets all adjustment to their previous levels.

Store

To store the image data adjusted manually, move the red frame pointer to the Store icon and press the SELECT button. The Image Level Menu will appear. Move the red frame pointer to the Image 1 to 4 where you want to set and then press the SELECT button.

Quit

Closes the Image Adjust Menu.

Image Adjust Menu

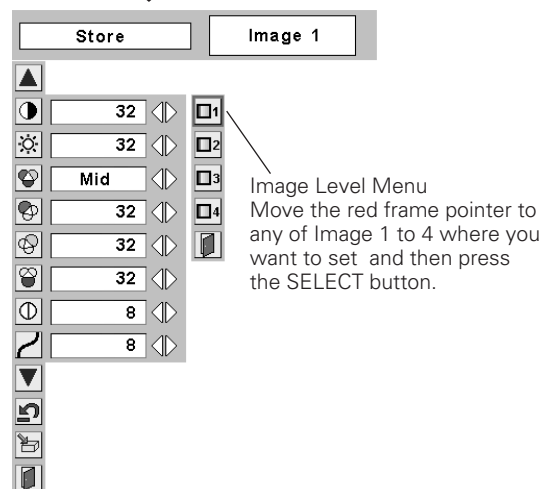
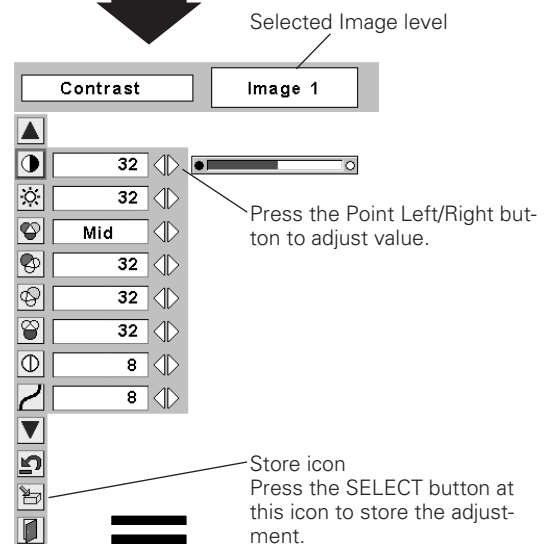
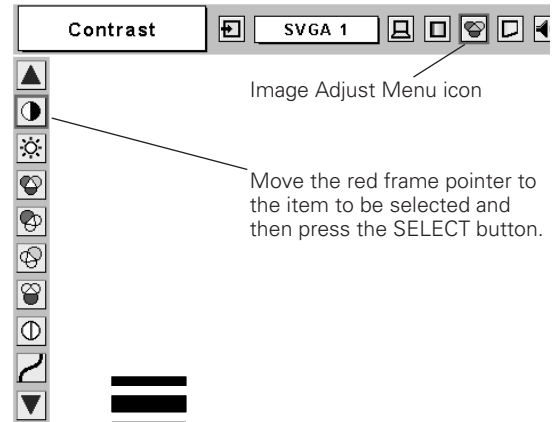

Screen Size Adjustment

This projector has a picture screen resize function, which enables you to display the desirable image size.

- 1 Press the MENU button and the On-Screen Menu will appear. Press the Point Left/Right button to move the red frame pointer to the Screen Menu icon.
- 2 Press the Point Down button and move the red frame pointer to the function that you want to select and then press the SELECT button.

Normal

Provides image to fit screen size.

True

Provides image in its original size. When the original image size is larger than the screen size (1024 x 768), this projector enters "Digital zoom +" mode automatically.

Wide

Provides image to fit wide video aspect ratio (16 : 9) by expanding image width uniformly. This function can be used for providing a squeezed video signal at 16 : 9.

Digital zoom +

When the Digital zoom + is selected, the On-Screen Menu disappears and the message "D. Zoom +" is displayed. Press the SELECT button to expand the image size. And press the Point Up/Down/Left/Right button to pan the image. The Panning function can work only when the image is larger than the screen size.

A projected image can be also expanded by pressing the D.ZOOM ▲ button on the remote control.

Digital zoom -

When the Digital zoom - is selected, the On-Screen Menu disappears and the message "D. Zoom -" is displayed. Press the SELECT button to compress the image size.

A projected image can be also compressed by pressing the D.ZOOM ▼ button on the remote control.

To cancel the Digital Zoom +/- mode, press any button except the D.ZOOM ▲/▼, SELECT, R-CLICK, and Point button.

Screen Menu

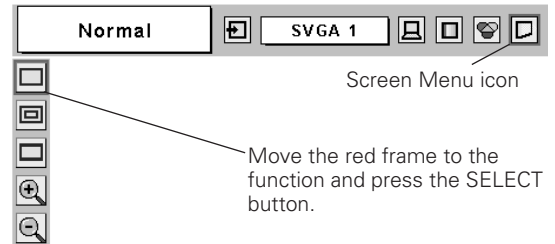

NOTE

- This Screen Menu cannot be operated when "720p (HDTV)", "1035i (HDTV)", or "1080i (HDTV)" is selected in the PC System Menu (p25).
- The True and Digital zoom +/- cannot be selected when "480i", "575i", "480p", or "575p" is selected in the PC System Menu (p25).
- This projector cannot display any resolution higher than 1280 X 1024. If your computer's screen resolution is higher than 1280 X 1024, reset the resolution to the lower before connecting to the projector.
- The image data in other than XGA (1024 x 768) is modified to fit the screen size in initial mode.
- The panning function may not operate properly if the computer system prepared in the PC Adjust Menu is used.

Video Input

Input Source Selection (Video, S-Video)

Direct Operation

Choose Video by pressing the INPUT button on the top control or the VIDEO button on the remote control.

Before using these buttons, correct input source should be selected through menu operation as described below.

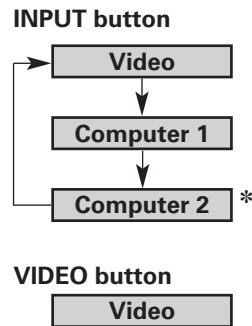

* When Monitor out is selected at the Terminal item in the Setting Menu, Computer 2 is not displayed.

Menu Operation

- 1 Press the MENU button and the On-Screen Menu will appear. Press the Point Left/Right button to move the red frame pointer to the Input Menu icon.
- 2 Press the Point Down button to move the red arrow pointer to Video and then press the SELECT button. The Source Select Menu will appear.
- 3 Move the pointer to the source that you want to select and then press the SELECT button.

Auto When selecting Auto, the projector automatically detects incoming video signal, and adjusts itself to optimize its performance. The projector selects connection in the following order:
1st S-Video
2nd Video
The S-VIDEO jack has priority over the VIDEO jack under the condition of connecting both the S-VIDEO jack and the VIDEO jack.

Video When video input signal is connected to the VIDEO jack, select Video.

S-Video When video input signal is connected to the S-VIDEO jack, select S-Video.

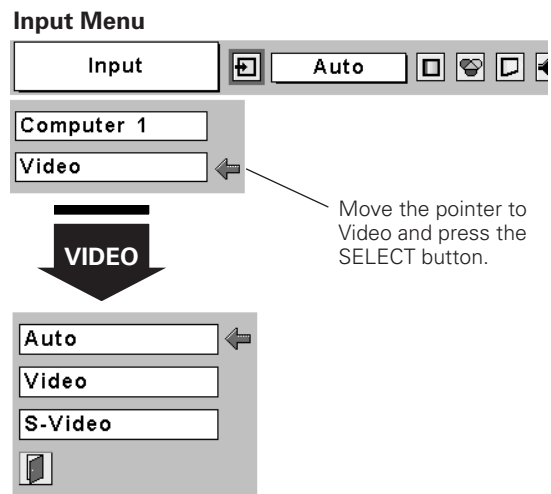

Move the pointer to Video and press the SELECT button.

Source Select Menu (VIDEO)

Move the pointer to the source that you want to select and press the SELECT button.

* When Monitor out is selected at the Terminal item in the Setting Menu, Computer 2 is not displayed.

NOTE

- See "Computer Input" on page 24 for a signal compatible with HDCP.

Input Source Selection (Component, RGB Scart 21-Pin)

Direct Operation

Choose Computer 2 by pressing the INPUT button on the top control or press the COMPUTER button on the remote control. Before using these buttons, correct input source should be selected through menu operation as described below.

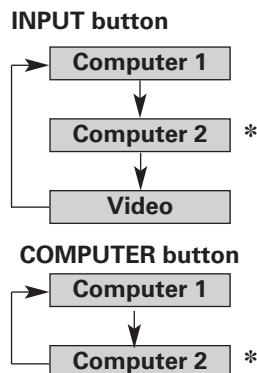

* Computer 2 is not displayed when the COMPUTER IN 2/COMPONENT IN/MONITOR OUT terminal is used as Monitor out.

Menu Operation

- 1 Press the MENU button and the On-Screen Menu will appear. Press the Point Left/Right button to move the red frame pointer to the Input Menu icon.
- 2 Press the Point Down button to move the red arrow pointer to Computer 2 (Only the Computer 1 is displayed when Monitor out is selected in the Setting Menu.), and then press the SELECT button. The Source Select Menu will appear.
- 3 Move the pointer to the correct input source and then press the SELECT button.

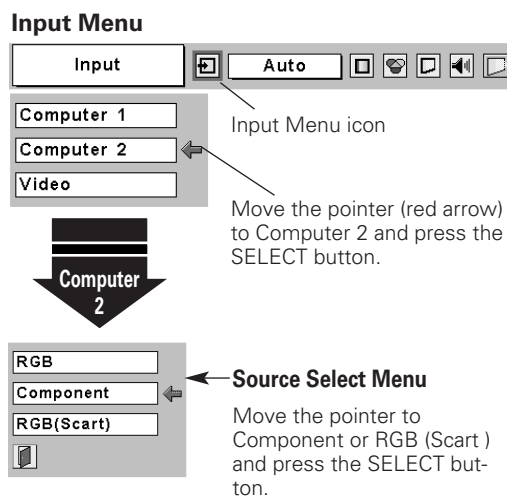

Component

When the input source is coming from video equipment connected to the COMPUTER IN 2/COMPONENT IN/MONITOR OUT terminal with a Component-VGA Cable, select Component.

RGB (Scart)

When the input source is coming from video equipment connected to the COMPUTER IN 2/COMPONENT IN/MONITOR OUT terminal with a Scart-VGA Cable, select RGB (Scart).

NOTE

- Component-VGA Cable and Scart-VGA Cable are optionally supplied. See page 53 for order.

Video System Selection

- 1 Press the MENU button and the On-Screen Menu will appear. Press the Point Left/Right button to move the red frame pointer to the AV System Menu icon.
- 2 Press the Point Down button to move the red arrow pointer to the system that you want to select and then press the SELECT button.

Video or S-Video

Auto

The projector automatically detects incoming video system, and adjusts itself to optimize its performance. When Video System is PAL-M or PAL-N, select system manually.

PAL / SECAM / NTSC / NTSC4.43 / PAL-M / PAL-N

If the projector cannot reproduce proper video image, it is necessary to select a specific broadcast signal format among PAL, SECAM, NTSC, NTSC 4.43, PAL-M, and PAL-N.

AV System Menu (Video or S-Video)

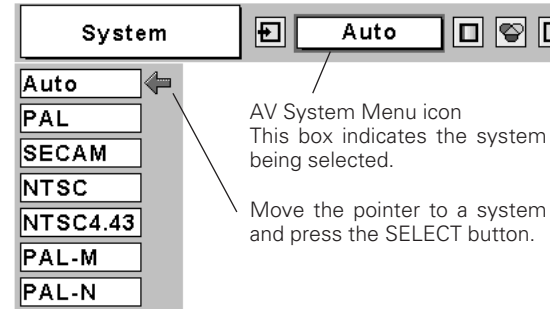

Component

Auto

The projector automatically detects incoming video signal, and adjusts itself to optimize its performance.

COMPONENT VIDEO SIGNAL FORMAT

If the projector cannot reproduce proper video image, it is necessary to select a specific component video signal format among 480i, 575i, 480p, 575p, 720p, 1035i, and 1080i.

AV System Menu (Component)

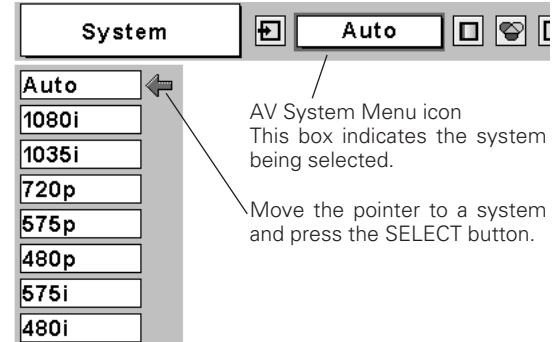

NOTE

- The AV System Menu cannot be selected when selecting RGB(Scart).

Image Level Selection

Direct Operation

Select an image level among Standard, Cinema, Image 1, Image 2, Image 3, and Image 4 by pressing the IMAGE button on the remote control.

Standard

Normal picture level preset on this projector.

Cinema

Picture level adjusted for the picture with fine tone.

IMAGE 1~4

User preset image in the Image Adjust Menu (p36, 37).



Menu Operation

- 1** Press the MENU button and the On-Screen Menu will appear. Press the Point Left/Right button to move the red frame pointer to the Image Select Menu icon.
- 2** Press the Point Down button to move the red frame pointer to the level that you want to set and then press the SELECT button.

Standard

Normal picture level preset on this projector.

Cinema

Picture level adjusted for the picture with fine tone.

IMAGE 1~4

User preset image in the Image Adjust Menu (p36, 37).

Image Select Menu

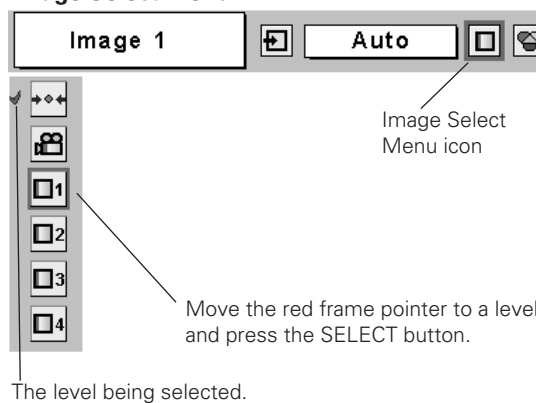

Image Level Adjustment

1 Press the MENU button and the On-Screen Menu will appear. Press the Point Left/Right button to move the red frame pointer to the Image Adjust Menu icon.

2 Press the Point Down button to move the red frame pointer to the item that you want to adjust and then press the SELECT button. The level of each item is displayed. Adjust each level by pressing the Point Left/Right button.

Contrast

Press the Point Left button to decrease contrast and the Point Right button to increase contrast. (From 0 to 63.)

Brightness

Press the Point Left button to adjust image darker and the Point Right button to adjust image brighter. (From 0 to 63.)

Color

Press the Point Left button to lighten color and the Point Right button to deepen color. (From 0 to 63.)

Tint

Press the Point Left/Right button to obtain proper color. (From 0 to 63.)

Color temp.

Press the Point Left/Right button for Color temp. level that you want to select. (XLow, Low, Mid, or High)

White balance (Red)

Press the Point Left button to lighten red tone and the Point Right button to deepen red tone. (From 0 to 63.)

White balance (Green)

Press the Point Left button to lighten green tone and the Point Right button to deepen green tone. (From 0 to 63.)

White balance (Blue)

Press the Point Left button to lighten blue tone and the Point Right button to deepen blue tone. (From 0 to 63.)

Sharpness

Press the Point Left button to soften the image and the Point Right button to sharpen the image. (From 0 to 15.)

Gamma

Press the Point Left/Right button to obtain better balance of contrast. (From 0 to 15.)

Progressive

Interlace video signal can be displayed in a progressive picture.

Off Not activated.

L1 Select "L1" for an active picture.

L2 Select "L2" for a still picture.

Image Adjust Menu



Image Adjust Menu icon

Move the red frame pointer to the item to be selected and then press the SELECT button.



Press the Point Left/Right button to adjust value.

Press the SELECT button at this icon to display other items.



Press the SELECT button at this icon to display previous items.

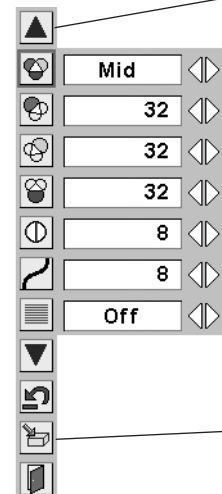

Press the SELECT button at this icon to store the value.

NOTE

- The Tint cannot be adjusted when the video system is PAL, SECAM, PAL-M, or PAL-N.
- Progressive cannot be selected when 480p, 575p, 720p, 1035i, or 1080i is selected.



Reset

Resets all adjustment to their previous figure.



Store

To store the adjustment data, move the red frame pointer to the Store icon and press the SELECT button. The Image Level Menu will appear. Move the red frame pointer to the Image Level 1 to 4 and then press the SELECT button.



Quit

Closes the Image Adjust Menu.

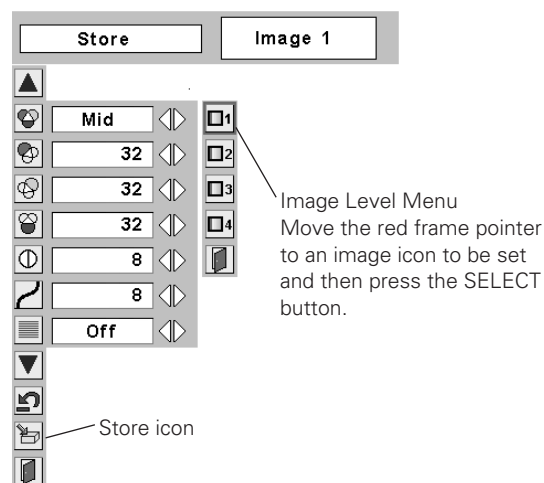

Screen Size Adjustment

This projector has a picture screen resize function, which enables you to display the desirable image size.

- 1 Press the MENU button and the On-Screen Menu will appear. Press the Point Left/Right button to move the red frame pointer to the Screen Menu icon.
- 2 Press the Point Down button and move the red frame pointer to the function that you want to select and then press the SELECT button.



Normal

Provides image at a normal video aspect ratio of 4 : 3.



Wide

Provides image at a wide screen ratio of 16 : 9.

Screen Menu

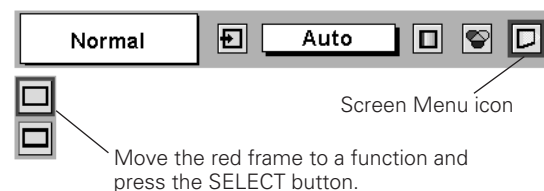

NOTE

- Screen Menu cannot be operated when "720p", "1035i", or "1080i" is selected in the AV System Menu (p34).

Setting

- 1 Press the MENU button and the On-Screen Menu will appear. Press the Point Left/Right button to move the red frame pointer to the Setting Menu icon.
- 2 Press the Point Down button to move the red frame pointer to the item that you want to set and then press the SELECT button. The Setting dialog box appears.

Language

The language used in the On-Screen Menu is available in English, German, French, Italian, Spanish, Portuguese, Dutch, Swedish, Russian, Chinese, Korean, or Japanese.

Keystone

This function corrects distortion of a projected image. Select either Store or Reset with the Point Left/Right button, and then press the Select button. The keystone dialog box appears. Adjust keystone with the Point Up/Down/Left/Right button.

Store stores the keystone adjustment even if the AC power cord is disconnected.

Reset resets the keystone adjustment when the AC power cord is disconnected.

Blue back

When this function is "On," the projector produces a blue image while input signal is not detected.

Display

This function decides whether to display On-Screen Displays.

On shows all the On-Screen Displays.

Off does not show On-Screen Displays except;

- On-Screen Menu
- "Power off?" message
- P-Timer
- "No signal" message
- "Wait a moment!" message

Logo

This function decides what to be displayed when starting up.

User the image you captured

Default the factory-set logo

Off count-down only

Capture

This function is used to capture the image being projected and use it for a starting-up display or interval of presentations. After capturing the projected image, go to the Logo function (above) and set it as "User". Then the captured image will be displayed when turning on the projector next time or pressing the NO SHOW button. (p21)

To capture the image, select [Yes]. To cancel the Capture function, select [No].

Before capturing an image, select Standard in the Image Select Menu to capture a proper image. (See page 29, 35.)

A signal from a computer can be captured up to XGA(1024 x 768). A signal from video equipment can be captured except for 720p, 1035i, and 1080i. When capturing the image that has been adjusted by the Keystone function, the adjustment data is automatically reset and the projector captures an image without keystone adjustment.

Setting Menu (Language)

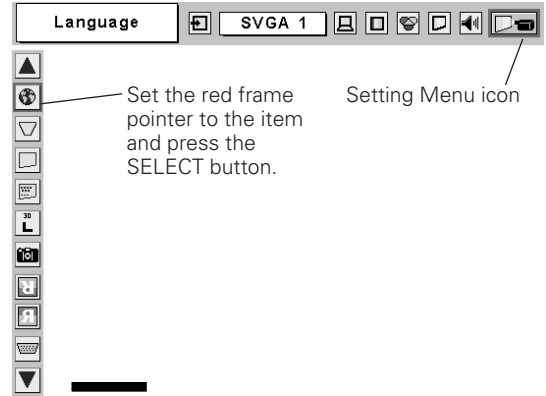

When pressing the SELECT button at Language, the Language Menu appears.

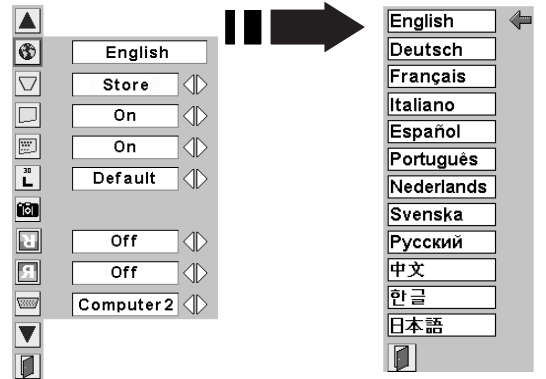

Capture

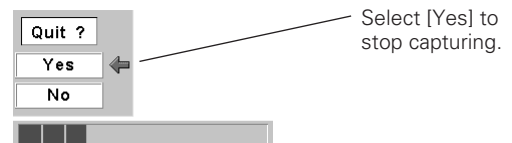
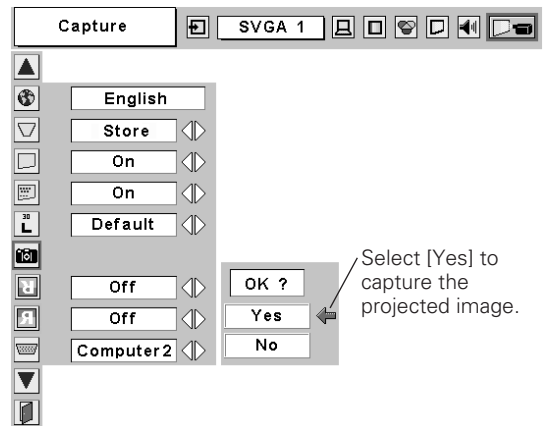

Ceiling

When this function is "On," the picture is top/bottom and left/right reversed. This function is used to project the image from a ceiling mounting the projector.

Ceiling

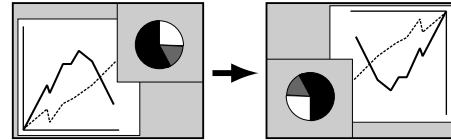

Rear

When this function is "On," the picture is left/right reversed. This function is used to project the image to a rear projection screen.

Rear

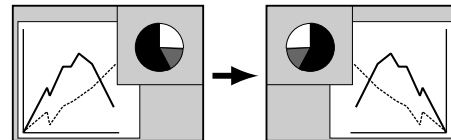

Terminal

The COMPUTER IN 2/COMPONENT IN/MONITOR OUT terminal on the back of the projector can be used as computer input or monitor output by switching Terminal with the Point Left/Right button.

To use the terminal as computer input, Component video input, or RGB Scart 21-Pin Video input, select Computer 2. To use the terminal as monitor out, select Monitor out.

Terminal cannot be switched into Monitor out after selecting Computer 2. In this case, select other input source such as Computer 1 or Video, and you will select Terminal.

Standby mode

This function is available when using an optional accessory attached to the DVI terminal, and it reduces standby energy when selecting Eco.

Eco reduces standby energy.

Normal consumes normal standby energy.

Standby mode

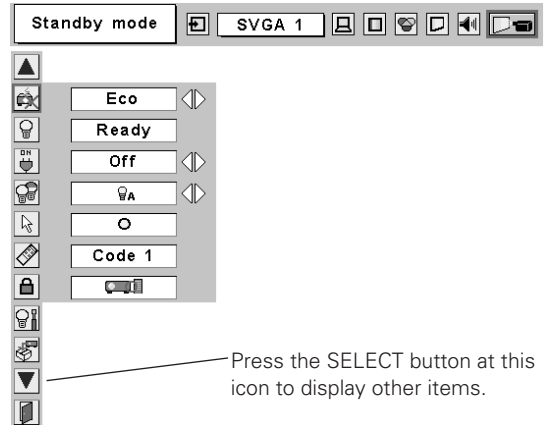

Power management

For reducing power consumption as well as maintaining the lamp life, the Power management function turns off the projection lamp when the input signal is interrupted and no button is pressed for 30 seconds or more.

When the input signal is interrupted and no button is pressed for 30 seconds or more, the timer display with the message "No signal" appears on the screen. The count-down starts for the time to have been set. The count-down time can be set between 1 and 30 minutes.

When the count-down time has elapsed, the lamp will be turned off to cool itself down. The POWER indicator is flashing red during this cooling-off period. The next performance depends on setting as follows.

Ready When the lamp has been fully cooled down, the POWER indicator changes to green flashing. In this condition, the projection lamp will be turned on if the input signal is reconnected or any button on the top control or remote control is pressed.

Shutdown.... When the lamp has been fully cooled down, the power will be turned off.

OffThe Power management function is canceled.

Power management

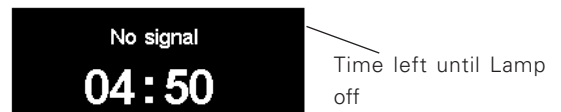

On start

When this function is "On," the projector is automatically turned on just by connecting the AC power cord to a wall outlet.

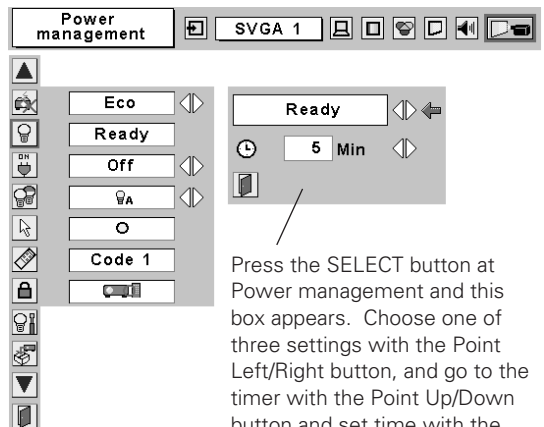



NOTE

- Be sure to turn the projector off properly (see "Turning Off the Projector" on page 19). If the projector is turned off in the wrong steps, the On start function does not operate properly.

Lamp mode

This function allows you to change brightness of the screen.

-  ... normal brightness
-  ... the controlled brightness according with input signal
-  ... lowers brightness and reduces the lamp power consumption.

Pointer

You can emphasize a part of the projected image with this function. Choose either Spotlight or Pointer with the Point Up/Down button and press the SELECT button. Then select one of three different sizes (Large, Middle, and Small) of Spotlight or a pointer of three different patterns (Arrow, Finger, and Dot) of Pointer. (See page 13 for operation.)

Remote control

This projector provides eight different remote control codes (Code 1-Code 8); the factory-set, initial code (Code 1) and the other seven codes (Code 2 to Code 8). This switching function prevents remote control interference when operating several projectors or video equipment at the same time.

For example operating the projector in "Code 7", both the projector and the remote control must be switched to "Code 7".

To change the code for the projector;



Select a remote control code in this Setting Menu.

To change the code for the remote control;

While holding down the MENU button, press the IMAGE button number of times corresponding to the remote control code for the projector. (See page 14 for details.)

Key lock

This function locks operation of the top control and remote control. It is useful to prevent operation by a third person.

-  ... not locked.
-  ... locks operation of the top control. To unlock, use the remote control.
-  ... locks operation of the remote control. To unlock, use the top control.

If the top control accidentally becomes locked and you do not have the remote control nearby, disconnect the AC power cord to turn off the power, and then while pressing the SELECT button, connect the AC power cord again. This will cancel the top control lock.

Lamp counter reset

This function is used to reset the lamp replace counter. When replacing the projection lamp, reset the lamp replace counter by using this function. See page 44 for operation.

Factory default

This function returns all setting values except for the lamp counter to the factory default settings.

Pointer

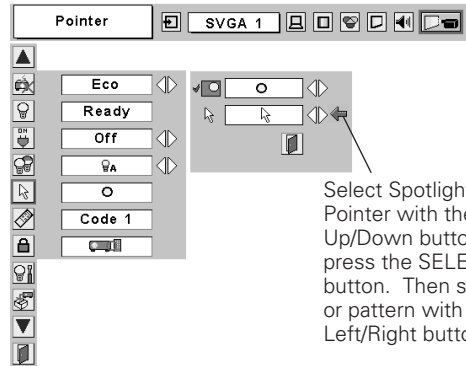

Select Spotlight or Pointer with the Point Up/Down button and press the SELECT button. Then select size or pattern with the Point Left/Right button.

Remote control

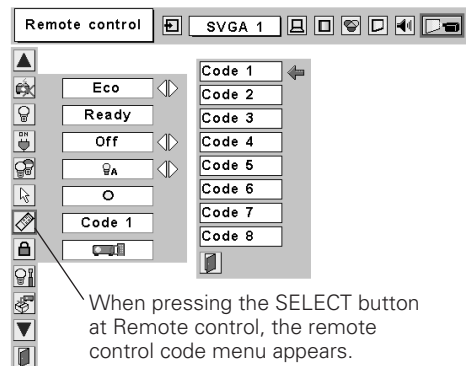

When pressing the SELECT button at Remote control, the remote control code menu appears.

Key lock

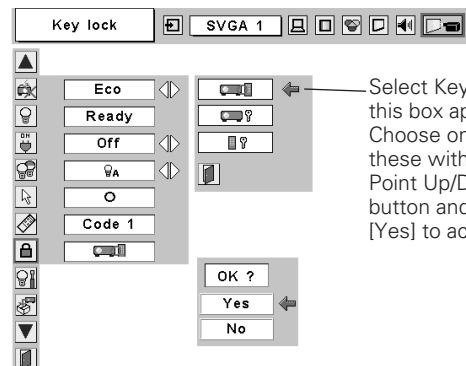

Select Key lock and this box appears. Choose one of these with the Point Up/Down button and select [Yes] to activate it.

Factory default

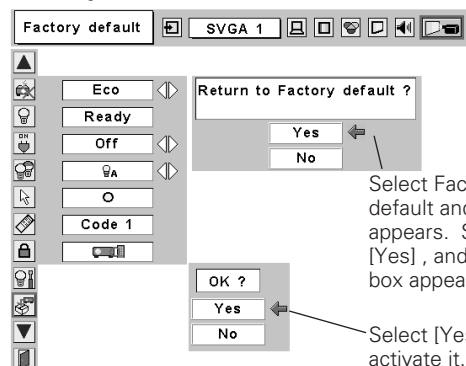

Select Factory default and this box appears. Select [Yes], and the next box appears.

Select [Yes] to activate it.

Maintenance and Cleaning

Warning Indicator

The WARNING indicator shows the state of the function which protects the projector. Check the state of the WARNING indicator and the POWER indicator to take proper maintenance.

The projector is shut down and the WARNING indicator is flashing red

When the temperature inside the projector exceeds the normal temperature, the projector is automatically shut down to protect the inside of the projector. The POWER indicator is flashing and the projector is being cooled down. When the temperature inside the projector returns to normal, the POWER indicator lights red and the projector can be turned on.

NOTE

- After the temperature inside the projector returns to normal, the WARNING indicator still continues to flash. When the projector is turned on again, the WARNING indicator stops flashing.

Then check the items below.

- ✓ Did you provide appropriate space for the projector to be ventilated? Check the installing condition to see if ventilation slots are not blocked.
- ✓ Is the projector not installed near the ventilation duct of air-conditioning equipment which may be hot? Install the projector away from the ventilation duct of air-conditioning equipment.
- ✓ Are the air filters clean? Clean the air filters periodically.

The projector is shut down and the WARNING indicator lights red

When the projector detects an abnormal condition, it is automatically shut down to protect the inside and the WARNING indicator lights red. In this case, disconnect the AC power cord and reconnect it, and then turn the projector on once again for check. If the projector is still turned off and the WARNING indicator lights red, disconnect the AC power cord and contact the service station for check and repair.



CAUTION

DO NOT LEAVE THE PROJECTOR WITH THE AC POWER CORD CONNECTED UNDER THE ABNORMAL CONDITION. IT MAY RESULT IN FIRE OR ELECTRIC SHOCK.

TOP CONTROL

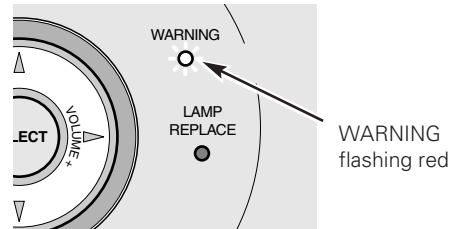

TOP CONTROL

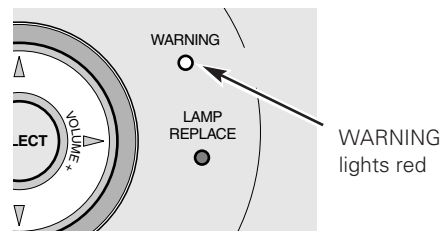

Cleaning the Air Filters

Air filters prevent dust from accumulating on the surface of the optical elements inside the projector. Should the air filters become clogged with dust particles, it will reduce cooling fans' effectiveness and may result in internal heat build up and adversely affect the life of the projector. Clean the air filters following the steps below.

- 1 Turn off the projector, and disconnect the AC power cord from the AC outlet.
- 2 Turn the projector upside down and remove the air filters by pulling the latches upward.
- 3 Clean the air filters with a brush or rinse them softly.
- 4 When cleaning the air filters by rinsing, dry them well. Replace the air filters properly. Make sure that the air filters are fully inserted.



CAUTION

Do not operate the projector with the air filters removed. Dust may accumulate on the LCD panel and the projection mirror degrading picture quality. Do not put small parts into the air intake vents. It may result in malfunction of the projector.

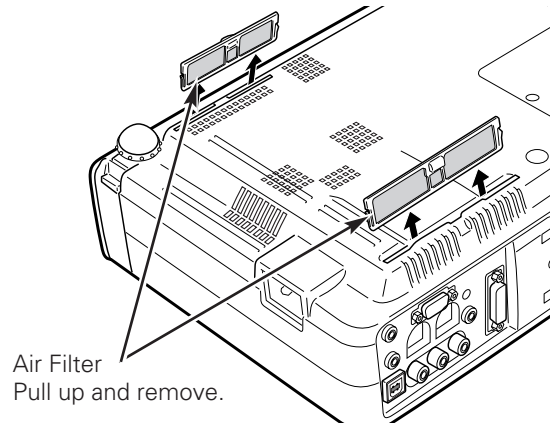

RECOMMENDATION

We recommend avoiding dusty/smoky environments when operating the projector. Usage in these environments may cause poor image quality.

When using under dusty or smoky conditions, dust may accumulate on a lens, LCD panels, or optical elements inside the projector. This condition may degrade the quality of a projected image. When the above symptoms are noticed, contact your authorized dealer or service station for proper cleaning.

Cleaning the Projection Lens

Follow these steps to clean the projection lens.

- 1 Disconnect the AC power cord before cleaning.
- 2 Softly wipe the projection lens with a cleaning cloth that contains a small amount of non-abrasive camera lens cleaner, or use lens cleaning paper or a commercially available air blower to clean the lens. Avoid using an excessive amount of cleaner. Abrasive cleaners, solvents, or other harsh chemicals might scratch the surface.
- 3 When the projector is not in use, replace the lens cover.

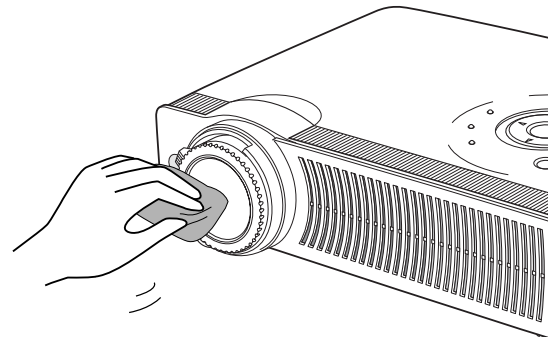

Cleaning the Projector Cabinet

Follow these steps to clean the projector cabinet.

- 1 Disconnect the AC power cord before cleaning.
- 2 Softly wipe the projector body with a soft, dry cleaning cloth. When it is heavily soiled, use a small amount of mild detergent and finish with a soft, dry cleaning cloth. Avoid using an excessive amount of cleaner. Abrasive cleaners, solvents, or other harsh chemicals might scratch the surface.
- 3 When the projector is not in use, put the projector in the carrying case to protect it from dust and scratches.

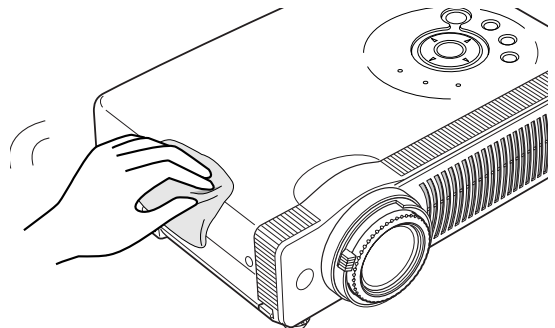

Lamp Replacement

When the life of the projection lamp of this projector draws to an end, the LAMP REPLACE indicator lights yellow. If this indicator lights yellow, replace the lamp with a new one promptly.

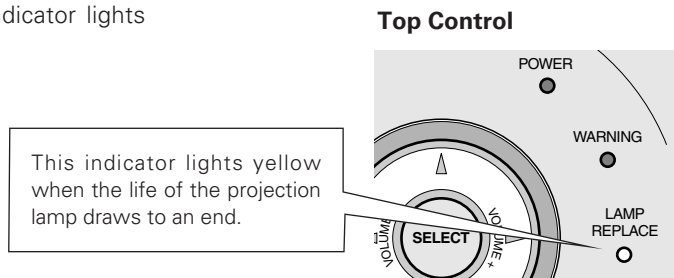

CAUTION

Allow a projector to cool, for at least 45 minutes before you open the Lamp cover. The inside of the projector can become very hot.



CAUTION

For continued safety, replace with a lamp of the same type. Do not drop a lamp or touch a glass bulb! The glass can shatter and may cause injury.

Follow these steps to replace the lamp.

- 1** Turn off the projector and disconnect the AC plug. Allow the projector to cool for at least 45 minutes.
- 2** Loosen the screw with a screwdriver, and remove the lamp cover.
- 3** Loosen 2 screws of the lamp with a screwdriver and pull out the lamp by grasping the handle.
- 4** Replace the lamp with a new one and tighten the 2 screws back into position. Make sure that the lamp is set properly. Replace the lamp cover and tighten the screw.
- 5** Connect the AC power cord to the projector and turn on the projector.
- 6** **Reset the Lamp replace counter.**
See "Lamp Replace Counter" on the next page.

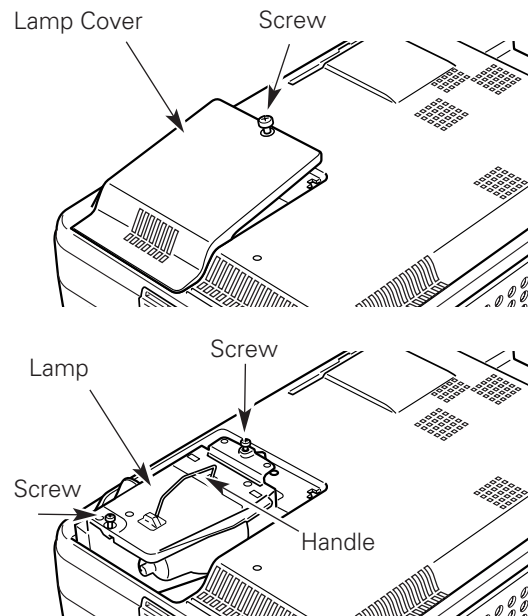

ORDER REPLACEMENT LAMP

Replacement lamp can be ordered through your dealer. When ordering a projection lamp, give the following information to the dealer.

- **Model No. of your projector** : **38-VIV208-01**
- **Replacement Lamp Type No.** : **03-000754-01P**
(Service Parts No. 610 309 2706)

Lamp Replace Counter

Be sure to reset the lamp replace counter after the lamp is replaced. When the lamp replace counter is reset, the LAMP REPLACE indicator stops lighting.

- 1 Turn the projector on, press the MENU button and the On-Screen Menu will appear. Press the Point Left/Right button to move the red frame pointer to the Setting Menu icon.
- 2 Press the Point Down button to move the red frame pointer to the Lamp counter reset item and then press the SELECT button. The message "Lamp replace counter Reset?" is displayed. Move the pointer to [Yes] and then press the SELECT button.
- 3 Another confirmation dialog box appears and select [Yes] to reset the Lamp replace counter.

NOTE

- Do not reset the Lamp replace counter without implementation of lamp replacement. Be sure to reset the Lamp replace counter only after replacing the lamp.

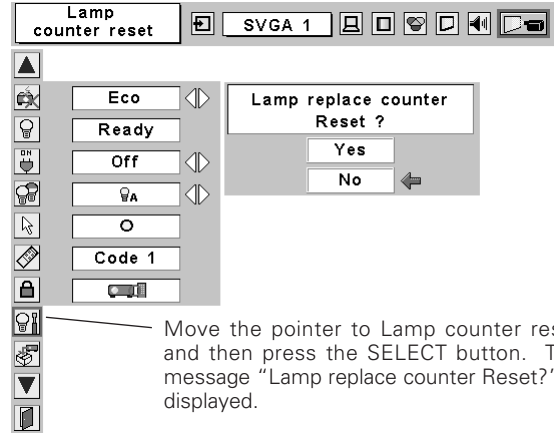

LAMP HANDLING PRECAUTIONS

This projector uses a high-pressure lamp which must be handled carefully and properly. Improper handling may result in accidents, injury, or create a fire hazard.

- Lamp lifetime may differ from lamp to lamp and according to the environment of use. There is no guarantee of the same lifetime for each lamp. Some lamps may fail or terminate their lifetime in a shorter period of time than other similar lamps.
- If the projector indicates that the lamp should be replaced, i.e., if the LAMP REPLACE indicator lights up, replace the lamp with a new one IMMEDIATELY after the projector has cooled down. (Follow carefully the instructions in the Lamp Replacement section of this manual.) Continuous use of the lamp with the LAMP REPLACE indicator lighted may increase the risk of lamp explosion.
- A Lamp may explode as a result of vibration, shock or degradation as a result of hours of use as its lifetime draws to an end. Risk of explosion may differ according to the environment or conditions in which the projector and lamp are being used.

IF A LAMP EXPLODES, THE FOLLOWING SAFETY PRECAUTIONS SHOULD BE TAKEN.

If a lamp explodes, disconnect the projector's AC plug from the AC outlet immediately. Contact an authorized service station for a checkup of the unit and replacement of the lamp. Additionally, check carefully to ensure that there are no broken shards or pieces of glass around the projector or coming out from the cooling air circulation holes. Any broken shards found should be cleaned up carefully. No one should check the inside of the projector except those who are authorized trained technicians and who are familiar with projector service. Inappropriate attempts to service the unit by anyone, especially those who are not appropriately trained to do so, may result in an accident or injury caused by pieces of broken glass.

Troubleshooting

Before calling your dealer or service center for assistance, check the items below once again.

- Make sure you have properly connected the projector to peripheral equipment as described in "Connecting to a Computer" and "Connecting to Video Equipment" on page 17 and 18.
- Make sure all equipment is connected to AC outlet and the power is turned on.
- When you operate the projector with a computer and it does not project an image, restart the computer.

Problem: - Try these solutions.

- No power**
- Plug the power cord of the projector into the AC outlet.
 - See if the POWER indicator lights red.
 - Wait 90 seconds after the projector is turned OFF when turning the projector back on. The projector can be turned on after the POWER indicator turns red. (See "Turning Off the Projector" on page 19.)
 - Check the WARNING indicator. If the WARNING indicator lights red, the projector cannot be turned on. (See "Warning Indicator" on page 41.)
 - Check the projection lamp. (See page 43.)
 - Unlock Key lock for the projector in the Setting Menu. (See page 40.)
-

- Image is out of focus.**
- Adjust focus of the projector.
 - Provide proper distance between the projector and the projection screen. (See page 16.)
 - Check the projection lens to see if it needs cleaning. (See page 42.)
 - Moving the projector from a cool temperature location to a warm temperature location may result in moisture condensation on the projection lens. In such an event, leave the projector OFF and wait until condensation disappears.
-

- No image**
- Check the connection between your computer or video equipment and the projector.
 - See if the input signal is correctly output from your computer. Some laptop computers may need changing the setting for monitor output when you are connecting a laptop computer. See your computer's user's manual for setting.
 - It takes about 30 seconds to display an image after turning on the projector.
 - See if the selected system is corresponding with your computer or video equipment.
 - Select correct input source once again through menu operation.
 - Make sure the temperature is not out of the Operating Temperature (5°C ~ 35°C).
-

- No sound**
- Check audio cable connection from audio input source.
 - Adjust the audio source.
 - Press the Volume (+) button.
 - Press the Mute button.
-

- Image is Left/Right reversed.**
- Check the Ceiling / Rear item. (See "Setting" on page 39.)
-

- Image is Top/Bottom reversed.**
- Check the Ceiling item. (See "Setting" on page 39.)
-

- Some displays are not seen during the Operation.**
- Check the Display item. (See "Setting" on page 38.)
-

Problem:	– Try these solutions.
Computer 2 cannot be selected.	– Select Computer 2 at the Terminal item in the Setting Menu. (See “Terminal” on page 39.)
The Terminal item cannot be selected.	– The Terminal item in the Setting Menu cannot be selected after Computer 2 is selected. Select other input source such as Computer 1 or Video with the INPUT button on the top control, the COMPUTER button or the VIDEO button on the remote control so that the Terminal item can be selected.
The Remote Control does not work.	<ul style="list-style-type: none">– Check the batteries.– Make sure no obstruction is between the projector and remote control.– Make sure you are not too far from the projector when using the remote control. Maximum operating range is 16.4' (5m).– Make sure the code of the remote control is conformed to the projector. (See page 14, 40.)– Unlock Key lock for the remote control in the Setting Menu. (See page 40.)
Wireless Mouse function does not work.	<ul style="list-style-type: none">– Make sure your computer is connected to the projector with a USB cable.– Check cable connection between the projector and your computer.– Check the mouse setting on your computer.

SERVICE

WARNING: High voltages are used to operate this projector. Do not attempt to open cabinet.

You can often correct operating problems yourself. If the projector fails to work properly, see "Troubleshooting" on pages 45 and 46.

If after following all operating instructions, you find that service is necessary, contact the Christie Service Station or store where you purchased the unit.

Give the model number and explain the difficulty. We will advise you how to obtain service.



























This symbol on the nameplate means the product is Listed by Underwriters Laboratories Inc. It is designed and manufactured to meet rigid U.L. safety standards against risk of fire, casualty and electrical hazards.



The CE Mark is a Directive conformity mark of the European Community (EC).

Indicators and Projector Condition

Check the indicators for projector condition.

Indicators			Projector Condition
POWER red/green	WARNING red	LAMP REPLACE yellow	
			The projector is OFF. (The AC power cord is unplugged.)
			The projector is preparing for stand-by or the projection lamp is being cooled down. The projector cannot be turned on until cooling is completed.
			The projector is ready to be turned on with the POWER ON-OFF button.
			The projector is operating normally.
			The projector is in the Power management mode.
			The temperature inside the projector is abnormally high. The projector cannot be turned on. When the projector is cooled down enough and the temperature returns to normal, the POWER indicator lights red and the projector can be turned on. (The WARNING indicator keeps flashing.) Check and clean the Air filter.
			The projector has been cooled down enough and the temperature returns to normal. When turning on the projector, the WARNING indicator stops flashing. Check and clean the air filters.
			The projector detects an abnormal condition and cannot be turned on. Unplug the AC power cord and plug it again to turn on the projector. If the projector is turned off again, disconnect the AC power cord and contact the dealer or the service center for service and checkup. Do not leave the projector on. It may cause electric shock or a fire hazard.

 ••• lights green.
  ••• flashes green.
  ••• lights red.
  ••• flashes red.
  ••• off

* When the life of the projection lamp draws to an end, the LAMP REPLACE indicator lights yellow. When this indicator lights yellow, replace the projection lamp with a new one promptly. Reset the Lamp replace counter after replacement of the lamp. See page 43 and 44.

Menu Tree

Computer Input / Video Input

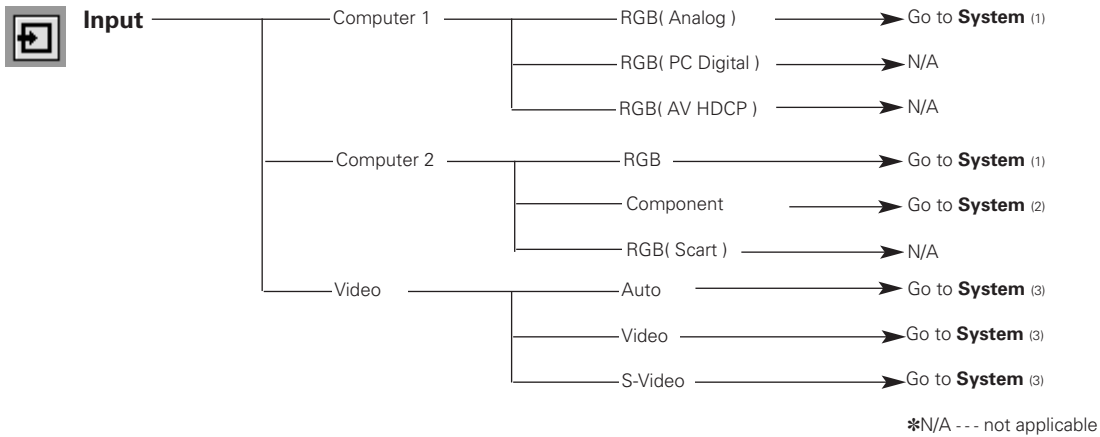

Computer Input

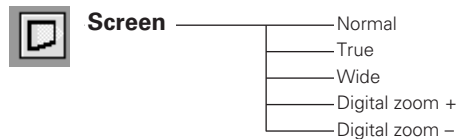
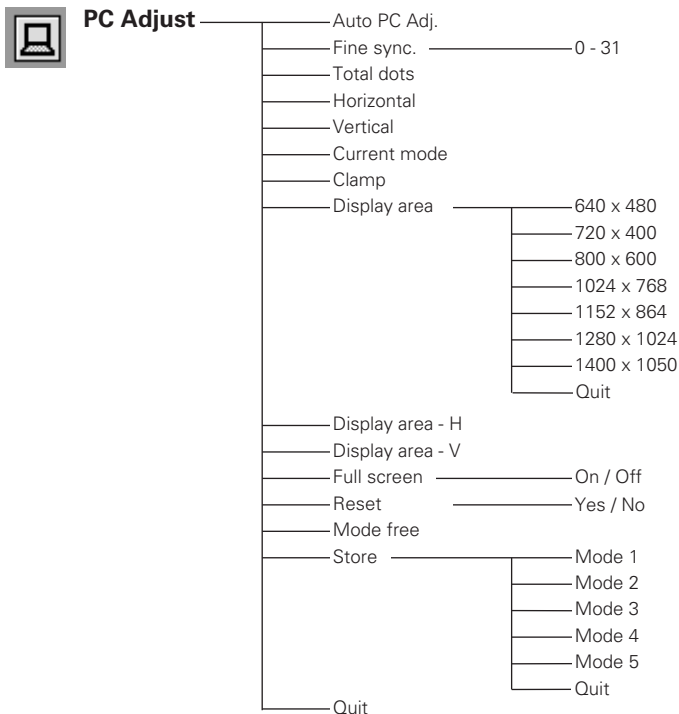
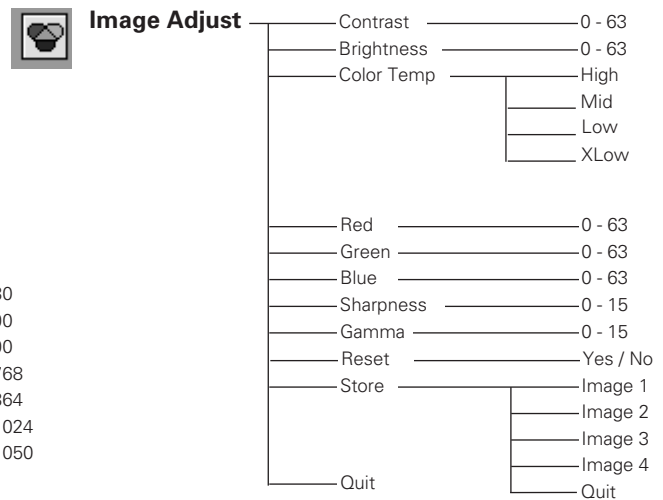
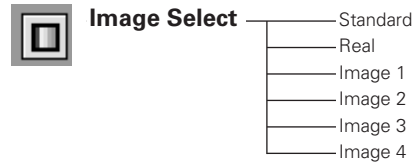
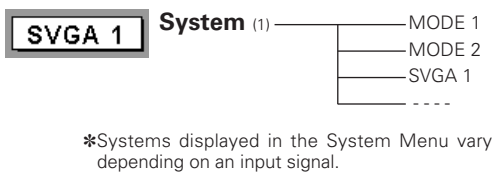

Video Input

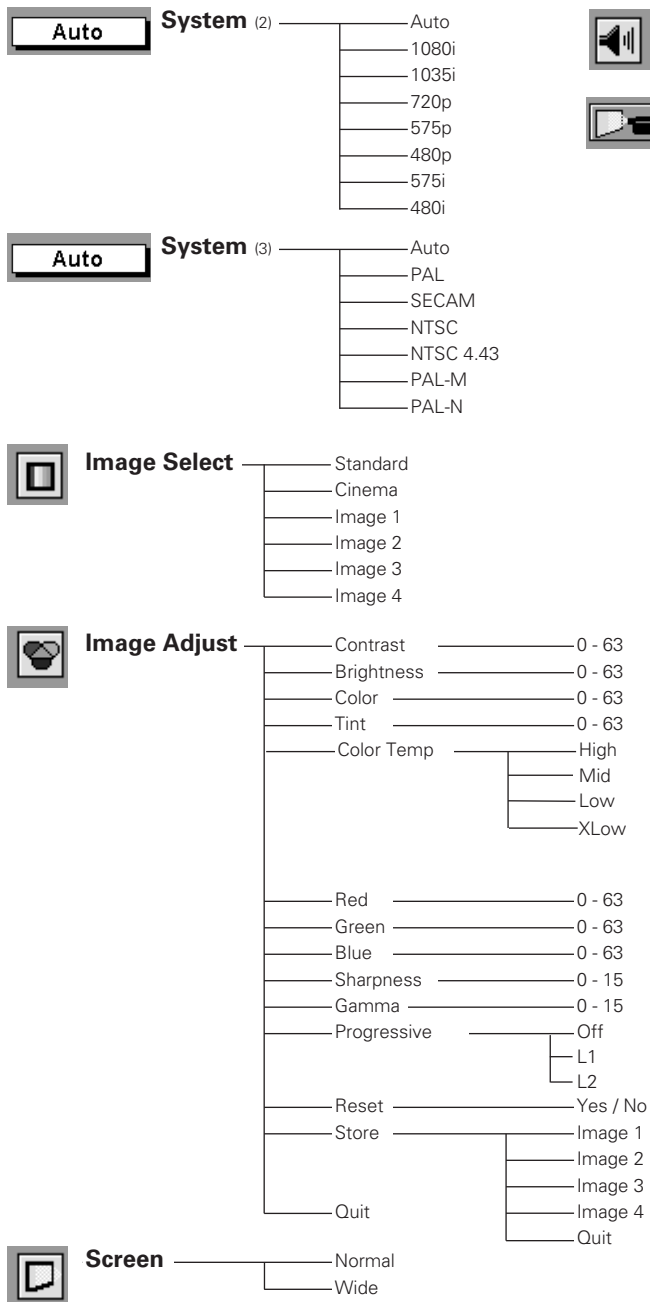

Setting

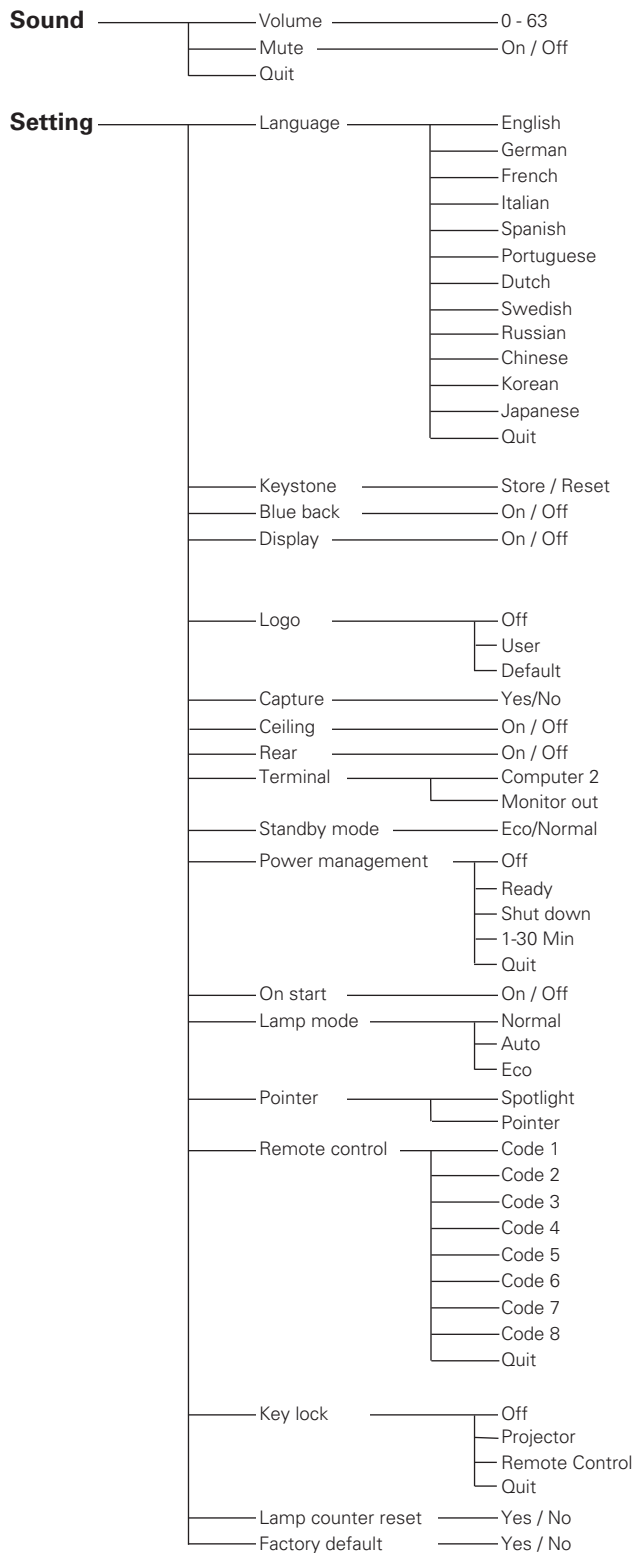

Compatible Computer Specifications

Basically this projector can accept the signal from all computers with the V, H-Frequency below mentioned and less than 140 MHz of Dot Clock.

ON-SCREEN DISPLAY	RESOLUTION	H-Freq. (kHz)	V-Freq. (Hz)	ON-SCREEN DISPLAY	RESOLUTION	H-Freq. (kHz)	V-Freq. (Hz)
VGA 1	640 x 480	31.47	59.88	XGA 12	1024 x 768	35.522	86.96 (Interlace)
VGA 2	720 x 400	31.47	70.09	XGA 13	1024 x 768	46.90	58.20
VGA 3	640 x 400	31.47	70.09	XGA 14	1024 x 768	47.00	58.30
VGA 4	640 x 480	37.86	74.38	XGA 15	1024 x 768	58.03	72.00
VGA 5	640 x 480	37.86	72.81	MAC 19	1024 x 768	60.24	75.08
VGA 6	640 x 480	37.50	75.00	MAC 21	1152 x 870	68.68	75.06
VGA 7	640 x 480	43.269	85.00	SXGA 1	1152 x 864	64.20	70.40
MAC LC13	640 x 480	34.97	66.60	SXGA 2	1280 x 1024	62.50	58.60
MAC 13	640 x 480	35.00	66.67	SXGA 3	1280 x 1024	63.90	60.00
575i	————	15.625	50.00 (Interlace)	SXGA 4	1280 x 1024	63.34	59.98
480i	————	15.734	60.00 (Interlace)	SXGA 5	1280 x 1024	63.74	60.01
SVGA 1	800 x 600	35.156	56.25	SXGA 6	1280 x 1024	71.69	67.19
SVGA 2	800 x 600	37.88	60.32	SXGA 7	1280 x 1024	81.13	76.107
SVGA 3	800 x 600	46.875	75.00	SXGA 8	1280 x 1024	63.98	60.02
SVGA 4	800 x 600	53.674	85.06	SXGA 9	1280 x 1024	79.976	75.025
SVGA 5	800 x 600	48.08	72.19	SXGA 10	1280 x 960	60.00	60.00
SVGA 6	800 x 600	37.90	61.03	SXGA 11	1152 x 900	61.20	65.20
SVGA 7	800 x 600	34.50	55.38	SXGA 12	1152 x 900	71.40	75.60
SVGA 8	800 x 600	38.00	60.51	SXGA 13	1280 x 1024	50.00	86.00 (Interlace)
SVGA 9	800 x 600	38.60	60.31	SXGA 14	1280 x 1024	50.00	94.00 (Interlace)
SVGA 10	800 x 600	32.70	51.09	SXGA 15	1280 x 1024	63.37	60.01
SVGA 11	800 x 600	38.00	60.51	SXGA 16	1280 x 1024	76.97	72.00
MAC 16	832 x 624	49.72	74.55	SXGA 17	1152 x 900	61.85	66.00
XGA 1	1024 x 768	48.36	60.00	SXGA 18	1280 x 1024	46.43	86.70 (Interlace)
XGA 2	1024 x 768	68.677	84.997	SXGA 19	1280 x 1024	63.79	60.18
XGA 3	1024 x 768	60.023	75.03	SXGA 21	1400 x 1050	63.90	60.00
XGA 4	1024 x 768	56.476	70.07	MAC	1280 x 960	75.00	75.08
XGA 5	1024 x 768	60.31	74.92	MAC	1280 x 1024	80.00	75.08
XGA 6	1024 x 768	48.50	60.02	480p	————	31.47	59.88
XGA 7	1024 x 768	44.00	54.58	575p	————	31.25	50.00
XGA 8	1024 x 768	63.48	79.35	720p	————	45.00	60.00
XGA 9	1024 x 768	36.00	87.17 (Interlace)	1035i	————	33.75	60.00 (Interlace)
XGA 10	1024 x 768	62.04	77.07	1080i	————	33.75	60.00 (Interlace)
XGA 11	1024 x 768	61.00	75.70	1080i	————	28.125	50.00 (Interlace)

When an input signal is digital from DVI terminal, refer to the chart below.

ON-SCREEN DISPLAY	RESOLUTION	H-Freq. (kHz)	V-Freq. (Hz)	ON-SCREEN DISPLAY	RESOLUTION	H-Freq. (kHz)	V-Freq. (Hz)
D-VGA	640 x 480	31.47	59.94	D-SXGA 2	1280 x 1024	60.276	58.069
D-480p	————	31.47	59.94	D-SXGA 3	1280 x 1024	31.65	29.80
D-575p	————	31.25	50.00	D-720p	————	45.00	60.00
D-SVGA	800 x 600	37.879	60.32	D-1035i	————	33.75	60.00 (Interlace)
D-XGA	1024 x 768	43.363	60.00	D-1080i	————	33.75	60.00 (Interlace)
D-SXGA 1	1280 x 1024	63.98	60.02	D-1080i	————	28.125	50.00 (Interlace)

Technical Specifications

Projector Type	Multi-media Projector
Dimensions (W x H x D)	11.73" x 2.8" x 8.58" (298mm x 71mm x 218mm) (not including raised portions)
Net Weight	6.2 lbs (2.8 kg)
LCD Panel System	0.8" TFT Active Matrix type, 3 panels
Panel Resolution	1,024 x 768 dots
Number of Pixels	2,359,296 (1,024 x 768 x 3 panels)
Color System	PAL, SECAM, NTSC, NTSC4.43, PAL-M, and PAL-N
High Definition TV Signal	480i, 480p, 575i, 575p, 720p, 1035i, and 1080i
Scanning Frequency	H-sync. 15 ~ 100 KHz, V-sync. 50 ~ 100 Hz
Projection Image size (Diagonal)	Adjustable from 40" to 300"
Projection Lens	F 1.7 ~ 2.5 lens with f 20.0 mm ~ 30.0 mm with manual zoom and focus
Throw Distance	3.3' ~ 25.3' (1.0 m ~ 7.7 m)
Projection Lamp	200 W
Video Input Jacks	RCA Type x 1 (Video) and Mini DIN 4 pin x 1 (S-Video)
Audio Input Jacks	RCA Type x 2
Computer Input 1 Terminal	DVI-I Terminal (Digital/Analog) (HDCP compatible)
Computer Input 2 / Component Input / Monitor Output Terminal	(VGA) HDB 15 Terminal x 1 (switch to use this terminal)
Computer / Component Audio Input Jack	Mini Jack (stereo) x 1
Service Port Connector	Mini DIN 8 pin x 1
USB Connector	USB Series B receptacle x 1
Audio Output Jack	Mini Jack (stereo) x 1 (variable with volume)
Internal Audio Amp	1.0 W RMS
Built-in Speaker	1 speaker, ϕ 1.1" (28mm)
Feet Adjustment	0° to 11.8°
Voltage and Power Consumption	AC 100 ~ 120 V (3.6 A Max. Ampere), 50 / 60 Hz (The U.S.A and Canada) AC 200 ~ 240 V (1.8 A Max. Ampere), 50 / 60 Hz (Continental Europe)
Operating Temperature	41 °F ~ 95 °F (5 °C ~ 35 °C)
Storage Temperature	14 °F ~ 140 °F (-10 °C ~ 60 °C)
Remote Control	Power Source : AA, UM3 or R06 Type x 2 Operating Range : 16.4' (5m) / \pm 30° Dimensions : 2.0" (W) x 1.0" (H) x 7.1" (D) (50mm x 27mm x 181mm) Net Weight : 0.34 lbs (154 g) (including batteries) Laser Pointer : Class II Laser (Max. Output : 1mW / Wave length : 640~660nm)
Accessories	User's Manual AC Power Cord Remote Control and Batteries DVI-VGA Cable USB Cable Carrying Bag Lens Cover String for Lens Cover

- The specifications are subject to change without notice.
- LCD panels are manufactured to the highest possible standards. Even though 99.99% of the pixels are effective, a tiny fraction of the pixels (0.01% or less) may be ineffective by the characteristics of the LCD panels.
- The On-Screen Menu and figures in this manual may differ slightly from the product.

Configurations of Terminals

COMPUTER INPUT/COMPONENT INPUT/MONITOR OUTPUT TERMINAL (ANALOG)

Terminal : HDB15-PIN

Pin Configuration

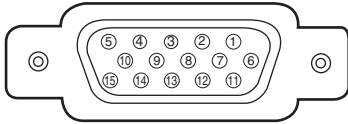

1	Red Input	9	+5V Power
2	Green Input	10	Ground (Vert.sync.)
3	Blue Input	11	Sense 0
4	Sense 2	12	DDC Data
5	Ground (Horiz.sync.)	13	Horiz. sync.
6	Ground (Red)	14	Vert. sync.
7	Ground (Green)	15	DDC Clock
8	Ground (Blue)		

DVI-I TERMINAL (DIGITAL/ANALOG)

Terminal : DVI-I

Pin Configuration

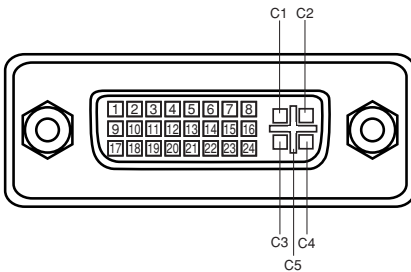

C1	Analog Red Input
C2	Analog Green Input
C3	Analog Blue Input
C4	Analog Horiz. sync
C5	Analog Ground (R/G/B)

1	T.M.D.S. Data2-	9	T.M.D.S. Data1-	17	T.M.D.S. Data0-
2	T.M.D.S. Data2+	10	T.M.D.S. Data1+	18	T.M.D.S. Data0+
3	T.M.D.S. Data2 Shield	11	T.M.D.S. Data1 Shield	19	T.M.D.S. Data0 Shield
4	No Connect	12	No Connect	20	No Connect
5	No Connect	13	No Connect	21	No Connect
6	DDC Clock	14	+5V Power	22	T.M.D.S. Clock Shield
7	DDC Data	15	Ground (for +5V)	23	T.M.D.S. Clock+
8	Analog Vert. sync	16	Hot Plug Detect	24	T.M.D.S. Clock-

SERVICE PORT CONNECTOR

Terminal : Mini DIN 8-PIN

Pin Configuration

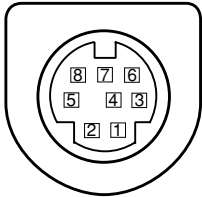

	PS/2	Serial	ADB
1	----	R X D	----
2	CLK	----	ADB
3	DATA	----	----
4	GND	GND	GND
5	----	RTS / CTS	----
6	----	T X D	----
7	GND	GND	----
8	----	GND	GND

USB CONNECTOR (Series B)

Pin Configuration

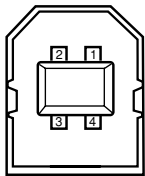

1	Vcc
2	- Data
3	+ Data
4	Ground

Optional Parts

The parts listed below are optionally supplied. When ordering those parts, give the name and Type No. to the sales dealer.

- **MAC Adapter**
- **DVI Cable**
- **COMPONENT-VGA Cable**
- **SCART-VGA Cable**
(This cable is used for RGB Scart 21-Pin Video output of video equipment.)

Attaching the Lens Cover

When moving this projector or when it is not used for an extended period, replace the lens cover.

- 1** Secure the string for the lens cover through a hole of the lens cover.
- 2** Turn the projector upside down and secure the string for lens cover to a hole on the bottom of the projector with a screw.

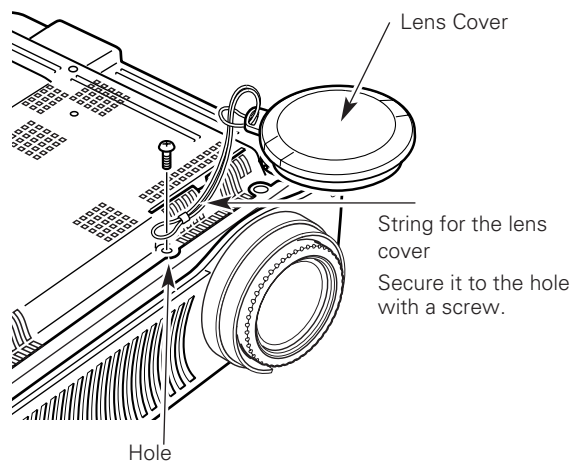



Project. Present. Perform.

CHRISTIE DIGITAL SYSTEMS, Inc.
809 Wellington Street North
Kitchener, Ontario
Canada N2G 4Y7
Telephone (519) 744-8005
North America call toll-free
1-800-265-2171 (sales)
Fax (519) 749-3136

CHRISTIE DIGITAL SYSTEMS, Inc.
10550 Camden Drive
Cypress, CA 90630
USA
Telephone (714) 236-8610
Fax (714) 503-3385
Toll Free 1-800-407-7727
Toll Free 1-800-333-3816

CHRISTIE DIGITAL SYSTEMS, Inc.
ViewPoint
200 Ashville Way
Wokingham, Berkshire, U.K.
RG41 2PL
Telephone +44 118 977-8000
Fax +44 118 977-8100
sales-europe@christiedigital.com

CHRISTIE DIGITAL SYSTEMS, Inc.
Willicher Damm 129
D-41066 Mönchengladbach Germany
Telephone +49 2161 664540
Fax +49 2161 664546
sales-germany@christiedigital.com

CHRISTIE DIGITAL SYSTEMS, Inc.
627A Aljunied Road
#05-02 Biz Tech Centre
Singapore 389842
Telephone 65-877-8737
Fax 65-877-8747

www.christiedigital.com

Printed in Japan

Part No. 10-A 610 309 1143 (1AA6P1P4208-- MT3K)